

AUG. 1924

RADIO BROADCAST

25 CENTS



Radio on Rum Row

The First Airship Radio,
and Rescue—
Captain Jack Irwin

TWO CONSTRUCTION ARTICLES:
A Two- and a Three-Tube
Roberts Set

4582



4582

AMERICAN RADIO & CO.

Garden City, N. Y.

Cunningham

RADIO TUBES

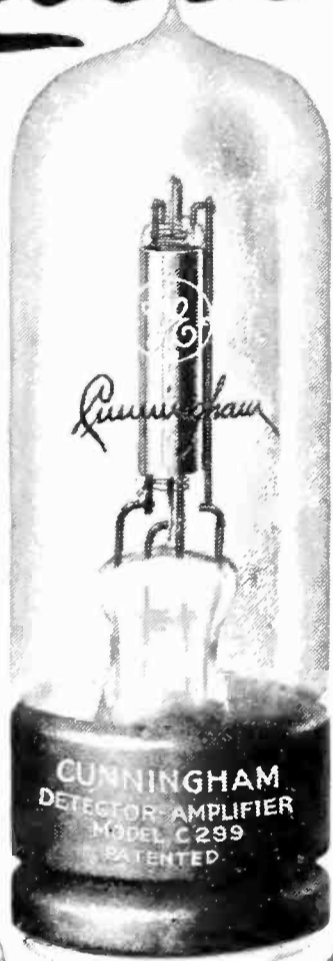

The Ideal TUBE ★ for Vacation Time

At the seashore—in one of our great national parks, or while motoring you will find the Cunningham Dry Battery Detector and Amplifier, Type C-299, the ideal Tube for your portable receiving set.

The special filament of this tube having a current so low that it may receive its supply from standard No. 6 Dry batteries or even from ordinary flashlight batteries, makes possible this entertaining application of Radio in places far remote.

Your dealer can give you useful suggestions for the purchase or construction of a highly efficient and practical portable Radio Set. Make this a Radio summer.

Cunningham C-299 Detector and Amplifier Tube	
C-299 3 volts .06 amp. Dry Battery	
Detector and Amplifier	\$5.00
Other Cunningham Radio Tubes	
C-301A—6 Volts 1-4 amp. Amplifier . .	\$5.00
C-300—6 Volts Gas Content Detector .	\$5.00
C-11—1.1 Volts .25 amp. Dry Battery	
Detector and Amplifier. Special Base	\$5.00
C-12—Similar to C-11 with standard base	\$5.00

Patent Notices Cunningham tubes are covered by patents dated 2-18-08, 2-18-12, 12-30-13, 10-23-17, 10-23-17 and others issued and pending. Licensed for amateur, experimental and entertainment use in radio communication. Any other use will be an infringement.

Cunningham 40-page Data Book fully explaining care and operation of Radio Tubes now available by sending 10c in Stamps to San Francisco office.

E. J. Cunningham Inc.

Home Office:
Branch 182 Second Street **Branch**
CHICAGO **SAN FRANCISCO** **NEW YORK**

★ Tested and approved by RADIO BROADCAST ★

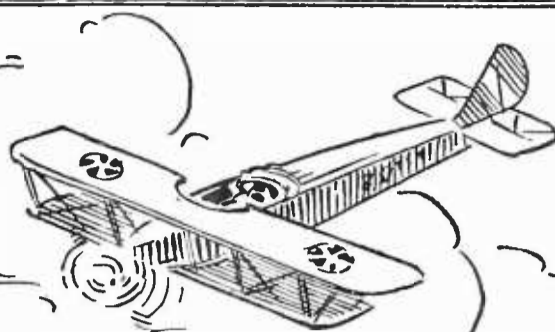
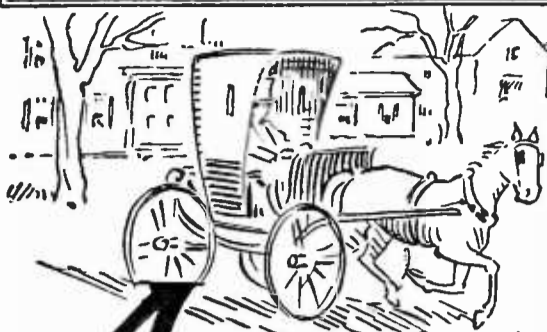

American Genius *To-Day* IN RADIO HEADSETS



WEIGHS
ONLY
8 OZ

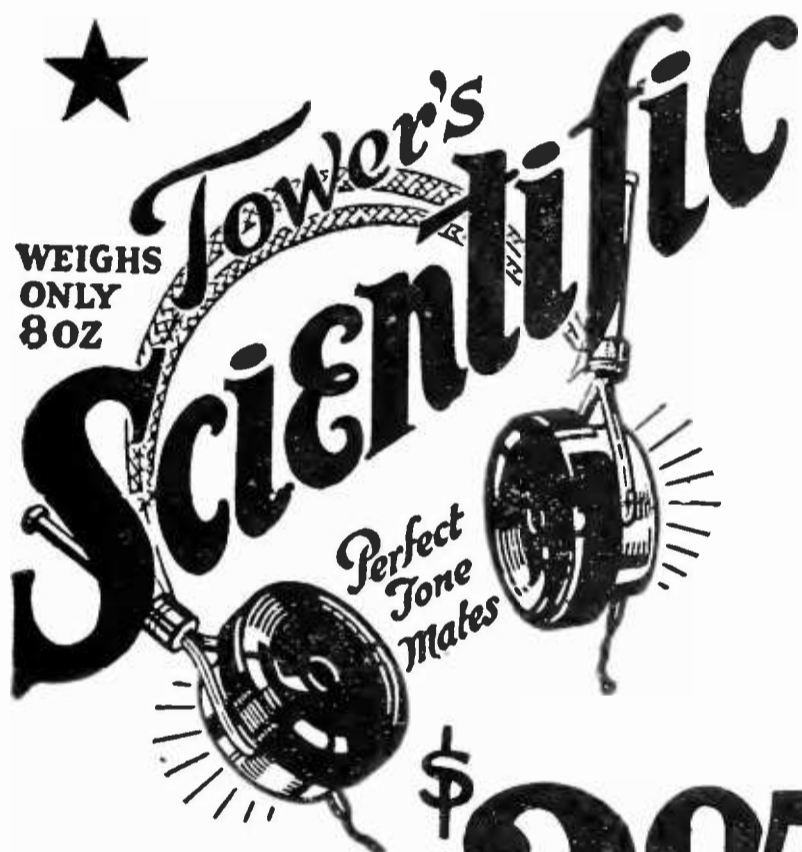

*Perfect
Tone
Mates*

\$

NOW 2.95

*Plus a few
cents Postage*

YOUR PROTECTION

Every set tested and approved by licensed radio operators. Every set covered with money-back guarantee.

Production, over one million double headsets for this season.

Order at once by post card and we will ship immediately by Parcel Post C. O. D.

THE TOWER MFG. CO.

98-1 Brookline Ave, Boston, Mass.



★ Tested and approved by RADIO BROADCAST ★

Radio Broadcast

ARTHUR H. LYNCH, EDITOR

AUGUST, 1924

COVER - - - - -	<i>From a Painting by Remington Schuyler</i>	
A PROPER SETTING FOR A SUPER-HETERODYNE - - - - -	<i>Frontispiece</i>	
A KNOCK-OUT SHORT-WAVE RECEIVER - - - - -	<i>Zeh Bouck</i>	279
RADIO ON RUM ROW - - - - -	<i>James C. Young</i>	286
THE WAY OF THE TRANSGRESSOR - - - - -	<i>William P. Green</i>	292
THE MARCH OF RADIO - - - - -	<i>J. H. Morecroft</i>	296
BUILDING A KNOCK-OUT THREE-TUBE ROBERTS SET - - - - -	<i>J. E. Roberts</i>	308
WHEN THE "AMERICA" PUT OUT TO SEA - - - - -	<i>Jack Irwin</i>	315
SOLVING THE PROBLEMS OF THE NEUTRODYNE - - - - -	<i>J. F. Dreyer, Jr.</i>	325
THE LISTENERS' POINT OF VIEW - - - - -	<i>Jennie Irene Mix</i>	332
IN THE R. B. LAB. - - - - -		339
How to Rebuild a Radak R-3 into a Reflex Receiver		
Another Four-Tube Knock-Out		
Other Coupling Resistances		
An A Battery Rectifier Permanently Installed for Charging B Batteries		
Home Made Ultra Efficient Inductances		
Building Your Own Lab		
ADDITIONAL BROADCASTING STATIONS IN THE UNITED STATES - - - - -		345
THE DX CONTEST WINNERS - - - - -		346
A WORD ABOUT KNOCK-OUT RECEIVERS - - - - -	<i>Arthur H. Lynch</i>	348
THE VACUUM TUBE AS AN AMPLIFIER - - - - -	<i>Walter Van B. Roberts</i>	350
THE GRID - - - - -		356
A Push-Pull Amplifier		
Dry Cell Tubes and Oscillation		
Audio-Frequency Transformer Troubles		
NEW EQUIPMENT - - - - -		358
AMONG OUR AUTHORS - - - - -		360

Copyright, 1924, by Doubleday, Page & Co. All rights reserved
TERMS: \$3.00 a year; single copies 25 cents

F. N. DOUBLEDAY, Pres.
RUSSELL DOUBLEDAY, Sec'y.

ARTHUR W. PAGE, Vice-Pres.
S. A. EVERITT, Treas.

NELSON DOUBLEDAY, Vice-Pres.
JOHN J. HESSIAN, Asst. Treas.

DOUBLEDAY, PAGE & CO.

THE WORLD'S WORK COUNTRY LIFE THE GARDEN MAGAZINE SHORT STORIES EDUCATIONAL REVIEW

GARDEN CITY, N. Y.

CHICAGO: People's Gas Bldg.

BOSTON: Tremont Bldg.

NEW YORK: 120 W. 32nd Street

Radiola Regenoflex, with Radiola Loudspeaker, and 4 Radiotrons WD-11; with space for batteries inside; (complete except batteries and antenna)

\$206



With a Radiola on the Front Porch

All the jazz of the big orchestras in faraway big towns comes through clearly for dancing. The fine music is true, sweet toned, undistorted. The sports news rings out with all the thrill of bleachers or ringside. The Regenoflex is a leader among the new Radiolas that are making this a great radio summer!

A Radiola Regenoflex on the front porch —and that porch can be way up in the mountains, or off at the seashore—but it's not too far away to be in on the fun.

The improvements in its mechanism offer greater sensitivity and greater selectivity; clearer tone; and complete simplicity. Where *quality* of reception counts as much as distance, the Regenoflex is the receiver for this summer's fun!

This symbol of quality  is your protection

"There's a Radiola for every purse"

Send for the free booklet that describes every Radiola.

Radio Corporation of America ★

Sales Offices

233 Broadway
New York

10 So. LaSalle Street
Chicago, Ill.

433 California Street
San Francisco, Cal.

RADIO CORPORATION OF AMERICA
Dept. 37 (Address office nearest you.)
Please send me your free Radio Booklet.

Name _____

Street Address _____

City _____ R. F. D. _____

State _____

Radiola

REG. U.S. PAT. OFF.

★ Tested and approved by RADIO BROADCAST ★

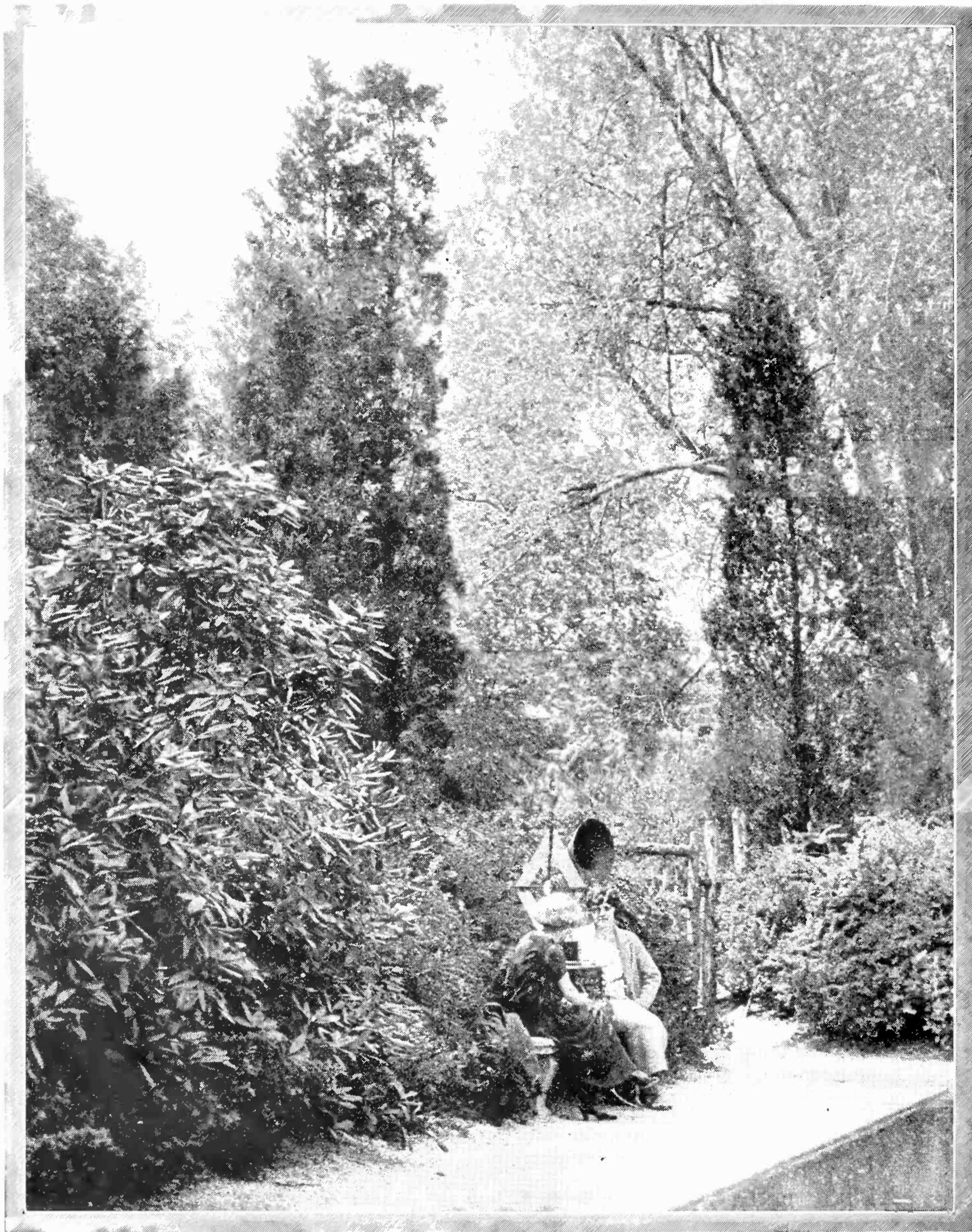

Roger B. Whitman, *Country Life*.

A PROPER SETTING FOR A SUPER-HETERODYNE

One of the eight-tube super-heterodynes, built in the RADIO BROADCAST laboratory, operating on a loop beside the North pool in the gardens of the Doubleday, Page & Company plant, where RADIO BROADCAST is published. A radio receiver can be ornamental, and decorative as well as useful

RADIO BROADCAST

Vol. 5, No. 4



August, 1924

A Knock-Out Short-Wave Receiver

Describing How to Build this Sensitive and Selective, Non-Radiating Receiver for Very Short Waves, Employing the Roberts Circuit

BY ZEH BOUCK

FOREWARNED is forearmed, and the writer maliciously announces that resonance will be treated in this article in terms of kilocycles rather than wavelengths. This is at all times the more efficient and logical consideration. Eventually, wavelength will be considered only secondarily and no better start can be made in thinking in kilocycles, than in a discussion of short waves, which we already refer to familiarly as higher *frequencies*.

As a final magnanimous concession to the vanquished, we state that the wave range to be considered in this article is from about 1360 kilocycles—220 meters—to a shade over 3000 kilocycles, a bit under 100 meters. 1500 kilocycles is the frequency of 200 meters, and 2000 kilocycles the vibratory rate of 150 meters. If the reader insists on being inefficient, and

must know the wavelengths of the intermediate frequencies, he will be under the necessity of dividing 300,000 by the number of kilocycles.

THE REQUIREMENTS OF A SHORT-WAVE SET

THE higher radio frequencies are less stable, more difficult to tune and control than the lower conventional broadcasting frequencies. They therefore impose more exacting requirements on the possible methods of reception.

Various losses, which are comparatively negligible on the higher waves, become more pronounced and have a more detrimental effect on transmission and reception on amateur and sub-amateur waves. While it is probable that the magnitude of these losses has been exaggerated, they nevertheless exist, and every possible precaution should be taken to reduce them. Large size wires, with a practical minimum of

A Good Thing—and a Small Package

The possibilities of very short-wave transmission and reception have been appreciated for several years, but RADIO BROADCAST has consistently declined to publish data on a high-frequency receiver while the single-circuit oscillator offered the only simple and efficient receiving system. Mr. Bouck tells you why, and our forbearance is amply repaid in the receiver he has designed.

Here is a receiver that will appeal most powerfully to the serious experimenter—the enthusiast interested in the short-wave transmission of KDKA at 3000 kilocycles (100 meters) and WGY at 2800 kilocycles (107 meters)—and to the relay amateur who will find this set designed with an especial, and perhaps instinctive regard to his particular problems by one of his own kind.—THE EDITOR.

insulation, should be employed in wiring and winding the inductances. The size of wire, of course, determines the actual resistances in the circuits, and the elimination of unnecessary insulation does away with a dielectric, which if employed consistently and needlessly, may add materially to capacity losses.

CAPACITY EFFECTS

AS THE frequency is raised the effect of capacity upon resonance becomes much more critical and marked. For instance, an addition of ten micro-microfarads (.00001 mfd.) to a circuit oscillating at 3000 kilocycles, at which frequency KDKA transmits short-wave telephony, will decrease the frequency by about 400 kilocycles. The same capacity added to a receiver or transmitter oscillating at 750 kilocycles (approximately the frequency of WJY, WOR and PWX) will cause a decrease of only 69 kilocycles.

It is quite obvious that body capacity effects present somewhat of a genuine problem on these high frequencies, especially when it is considered that most of the receiving carried on in this region is beat-note reception of continuous wave telegraph signals. In a poorly designed short-wave receiver, a slight motion of the hand in the vicinity of the tuning controls will be sufficient to whistle a station clean across the audible scale—and out. In the receiver to be described, body capacity has been reduced to a satisfactory minimum, by mounting the oscillating coils at right angles to and away from the panel, by connecting the stationary condenser plates to the grids, and by using metal dials insulated from both the ground and the instruments they control. (Grounded shielding would immediately introduce losses. The individual control dials act partly as shields, and at the same time reduce the capacitative coupling between the body and the instruments by

functioning as the common plate of two condensers connected in series).

The increased susceptibility of receivers of this type to capacity variations also makes vernier control a necessity. However, as a built-in vernier generally adds to the condenser losses, non-vernier condensers are recommended with vernier dials. The Accuratune dial, a true vernier and possessing the desirable insulated metal scale, was used by the author.

THERE MUST BE NO RADIATION

THE most important consideration of all is the necessity for a non-radiating receiver. This absolutely essential condition has proved a serious problem, for most of the communication carried on in the higher frequencies postulates a regenerative and oscillating receiver. It is an easy matter to build a single-circuit regenerator to operate in the region of megacycles but the radiation from such a receiver places it absolutely and irreconcilably beyond the pale. We are all painfully familiar with the havoc worked by such sets on the broadcasting frequencies. It is the writing on the wall, with an added and sinister emphasis, for radiation on amateur and

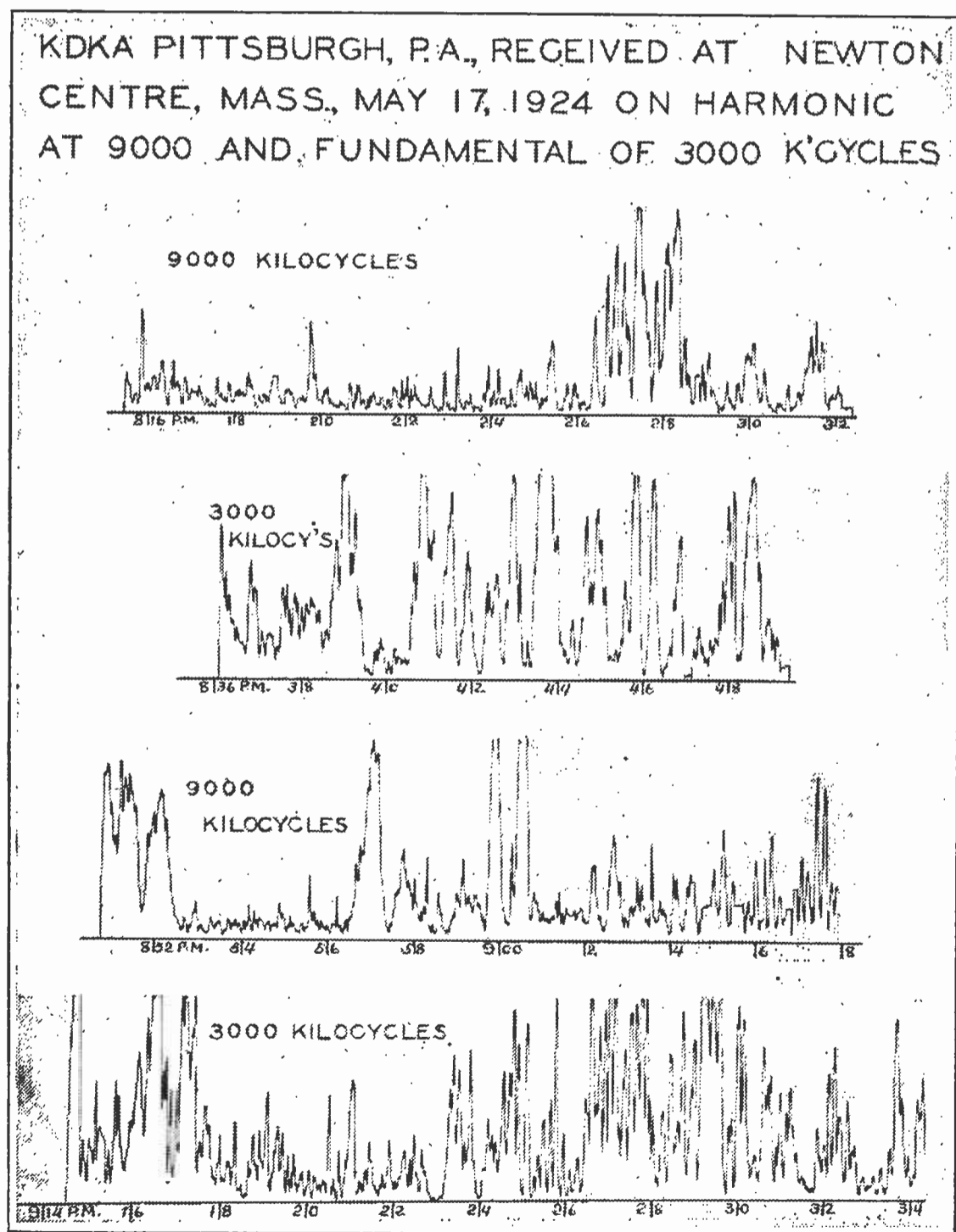

FIG. 1

Interesting graphs made by the signals themselves at the laboratory of Dr. Greenleaf Whittier Pickard. These tell why the short-wave receiver must not radiate

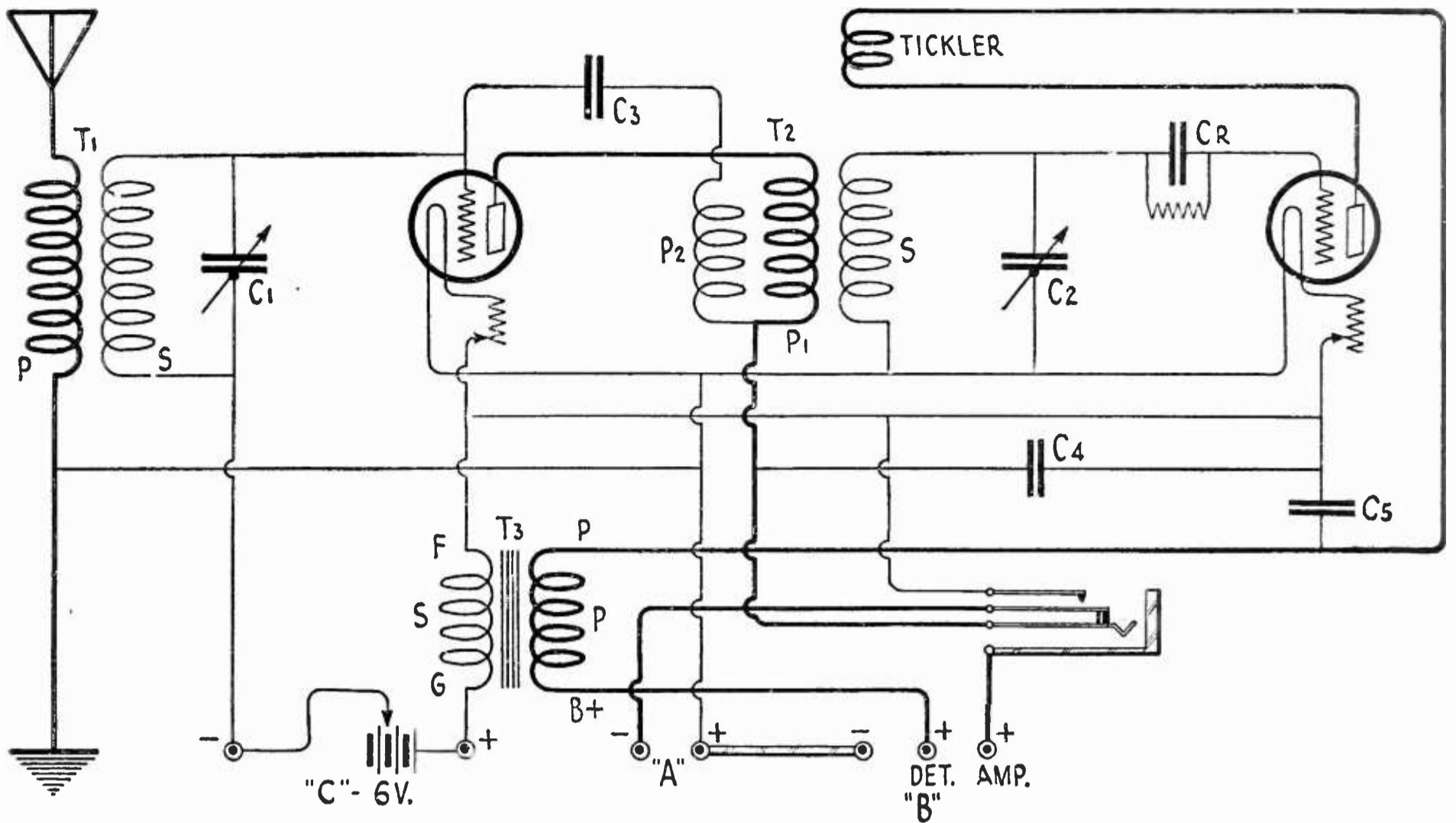

FIG. 2

The short-wave circuit. The C battery should be varied as one of the amplifier stabilizing adjustments.

sub-amateur waves possesses a remarkable carrying power that adds many miles to the radius of the interference area.

HOW THE HIGHER FREQUENCIES CARRY

THE possibilities of these very high frequencies are uncanny. Using a small regenerator with a ten *inch* antenna (needless to say, indoor), the writer has copied foreign low power stations operating in the neighborhood of 3000 kilocycles. Distant amateur stations have also been received on high harmonic frequencies which could represent only a small fraction of the already low power radiated on the fundamental. Dr. Greenleaf Whittier Pickard has had similar results in a room at the Commodore Hotel in New York City. Due to the freak element in these frequencies, distant broadcasting stations are often received much more consistently and loudly on their harmonics. KYW, at Chicago, is often recorded at Newton Centre, Massachusetts, on the 8th harmonic at greater intensity than on the fundamental. Doctor Pickard, in his study of short and long period variations, has made these extremely short waves photograph themselves; and has no unusual difficulty in obtaining a beautiful graph of the variations in WBBR's sixth harmonic at 7500 kilocycles. Fig. 1 shows a most remarkable photograph, which the author

is reproducing with the kind permission of Doctor Pickard. This masterpiece of laboratory finesse shows the simultaneous variations in strength of KDKA's fundamental at 3000 kilocycles (already far above the region of conventional broadcasting) and its third harmonic at 9000 kilocycles.

HOW TO PREVENT RADIATION?

WHILE it was quite obvious that radiation must be practically eliminated, the manner of overcoming it was less apparent. A blocking stage of radio-frequency amplification will immediately suggest itself to the experienced reader, as it did to the writer. However, this would necessitate a plate coil, and as the tendency to feed back through the capacity of the tube increases with the frequency, the amplifying bulb would prove a far more powerful oscillator than the detector—unless *efficient* means were taken to stabilize the circuit.

THE ROBERTS CIRCUIT ON SHORT WAVES

IT WAS upon the suggestion of the editor of RADIO BROADCAST that the writer began experimenting in his own amateur station, radio 2PI, with the possibilities of the Roberts receiver especially designed for short waves. As our readers who have followed Mr. Roberts's articles, on his "Two-Tube Knock-out Re-

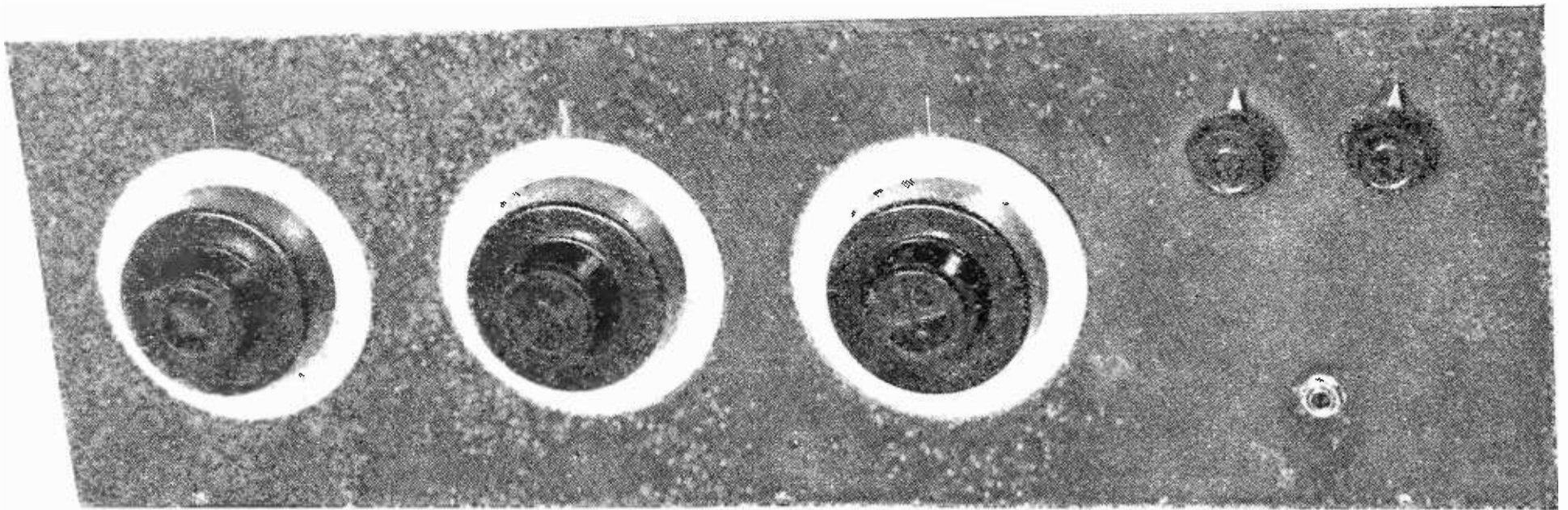

FIG. 3

Front view of the finished receiver. The dial arrangement is for left hand operation, the usual order of the tuning controls being reversed. The tickler is on the left.

ceiver" appreciate, this circuit employs one stage of tuned R. F. with capacity neutralization, bulb detection with regeneration, and one step of reflexed audio amplification. It was a happy thought of the editor and has developed into the receiver shown in the last five illustrations of this article, and which we have found to be in all ways the most desirable short-wave set we have ever operated. And we have played with many of them.

The circuit is shown in Fig. 2, and most of our readers will recognize it as the standard Roberts hook-up with a slight variation in T₁. A semi-periodic primary has been substituted for the tapped coil which is quite unnecessary and actually detrimental in high-frequency reception.

All inductances, excepting the windings of the audio amplifying transformer, are spiderwebs. The writer found it most convenient to obtain the standard Roberts broadcast wave

coils, made by the Eugene Turney Laboratories and rewind them for the special short-wave set. If the reader desires to make his own forms, they should have an odd number, say seventeen winding spokes, with a first-turn-diameter of two and a half inches. Pasteboard is the preferred material.

The primary of T₁ is wound with six turns of No. 18 wire. S, in both T₁ and T₂, has 25 turns (see General Instructions) with the inside terminals running to the grids. P₁ and P₂ in T₂, is the combined primary and neutralizing winding. It is made as follows: Two No. 22 wires, from individual spools, are wound simultaneously for eight and a half turns. This results in two parallel coils. The *beginning* of one coil is connected to the *end* of the other, giving a common terminal which leads to the output jack. The remaining two connections run to the plate and to the neutralizing condenser C₃ (it is immaterial which runs to which).

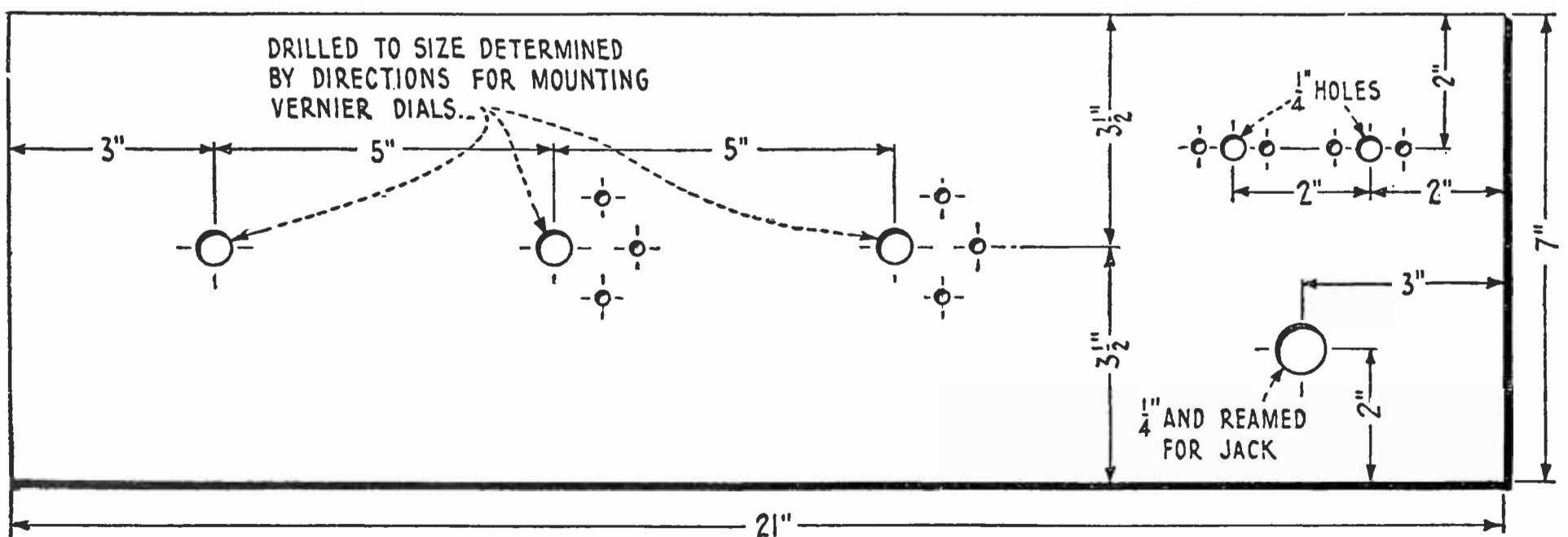

FIG. 4

The panel layout. The design is such as especially to suit the operating convenience of the majority of amateur stations

The tickler coil consists of eleven turns of No. 18 wire.

With the exception of the secondaries, all coils are wound over one, under one, in reference to the winding spokes. The secondaries, which are wound with No. 18 wire, are woven over three and under three.

Capacities C_1 and C_2 are .00025 mfd. low-loss, low minimum capacity variable condensers with the stationary plates connected to the grids. Duplex condensers were used by the writer. C_4 and C_5 are fixed capacities, respectively .001 mfd. and .002 mfd. (see General Instructions).

C_4 is the grid condenser and leak, having respective values of .0005 mfd. and 250,000 ohms (refer to General Instructions). The neutralizing condenser, C_3 , is made by winding No. 24 wire over two inches of spaghetti tubing and slipping this on a convenient length of bus-bar wire left projecting from the grid terminal of the amplifying socket. The capacity of this condenser is varied by slipping the insulated tube farther on or off the bus-bar.

T_3 is an Amertran audio-frequency transformer, connected as indicated by the marked terminals.

The output is plugged into a Carter open circuit filament control jack.

The reader need not confine himself to the specific parts used by the author. He may use the products of other manufacturers if he is certain that the substitute is of equal quality. But he must insist on this, for a single piece of inferior apparatus may impair the successful operation of a short-wave set.

THE PANEL

A BAKELITE panel, seven by twenty-one inches, was drilled according to the specifications in Fig. 3 and grained to a beautiful gray-black finish. The markers for the dial readings are scraped into the panel with the point of a dividers or scribe, and whitened with chalk or prepared paste. The simplicity of these three single lines is most pleasing, and harmonizes beautifully with the grained panel and the Accuratune dials.

CONSTRUCTION

THE various building details are clearly shown in the photographs, and adhere strictly to the theoretical implications contained in the earlier part of this article. Make all wiring as uncrowded and rigid as possible, using spaghetti sparingly and only where it is a necessity or a genuine convenience.

The writer has arranged the various controls

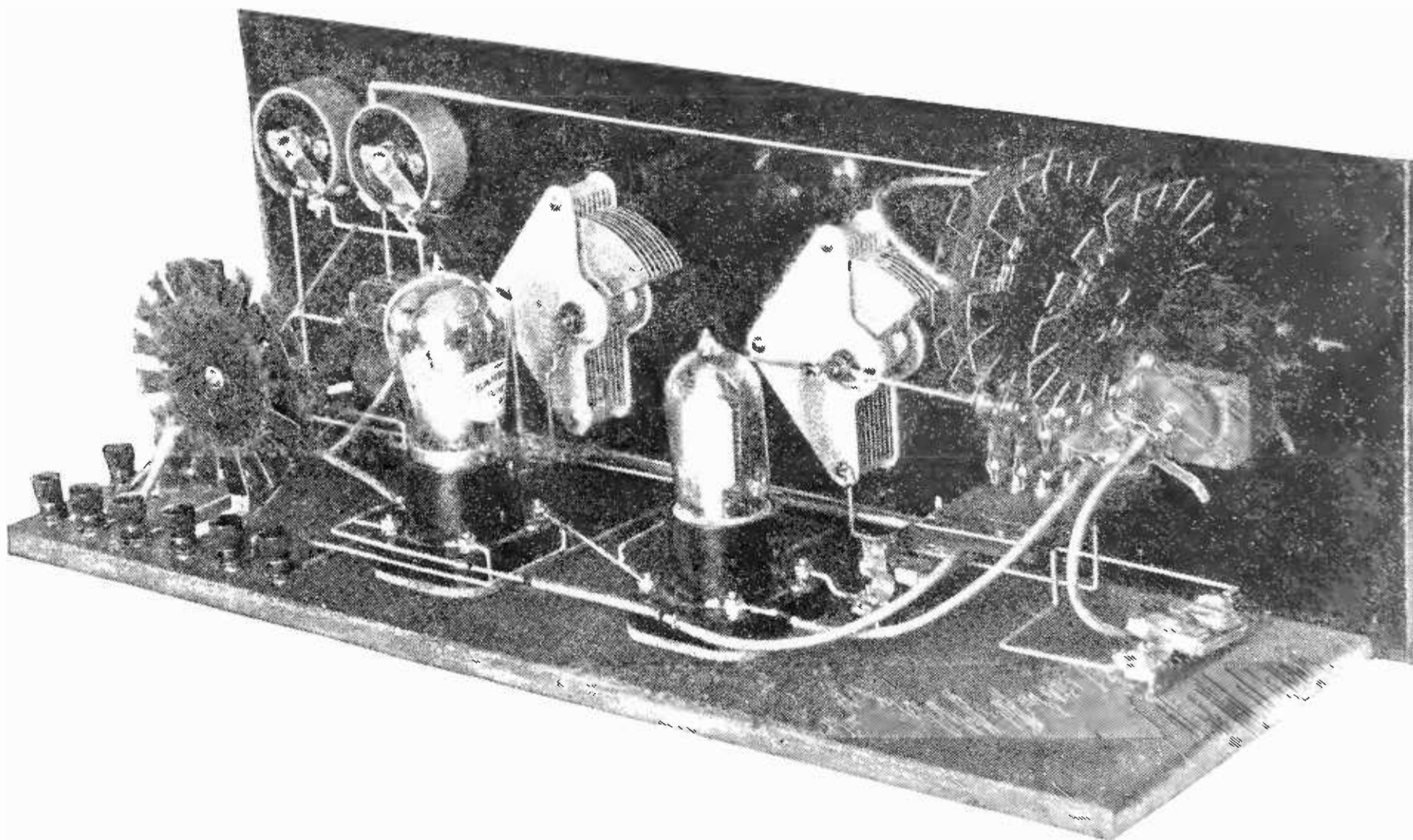

FIG. 5

Rear view. Spaghetti is used only where necessary, and on flexible leads

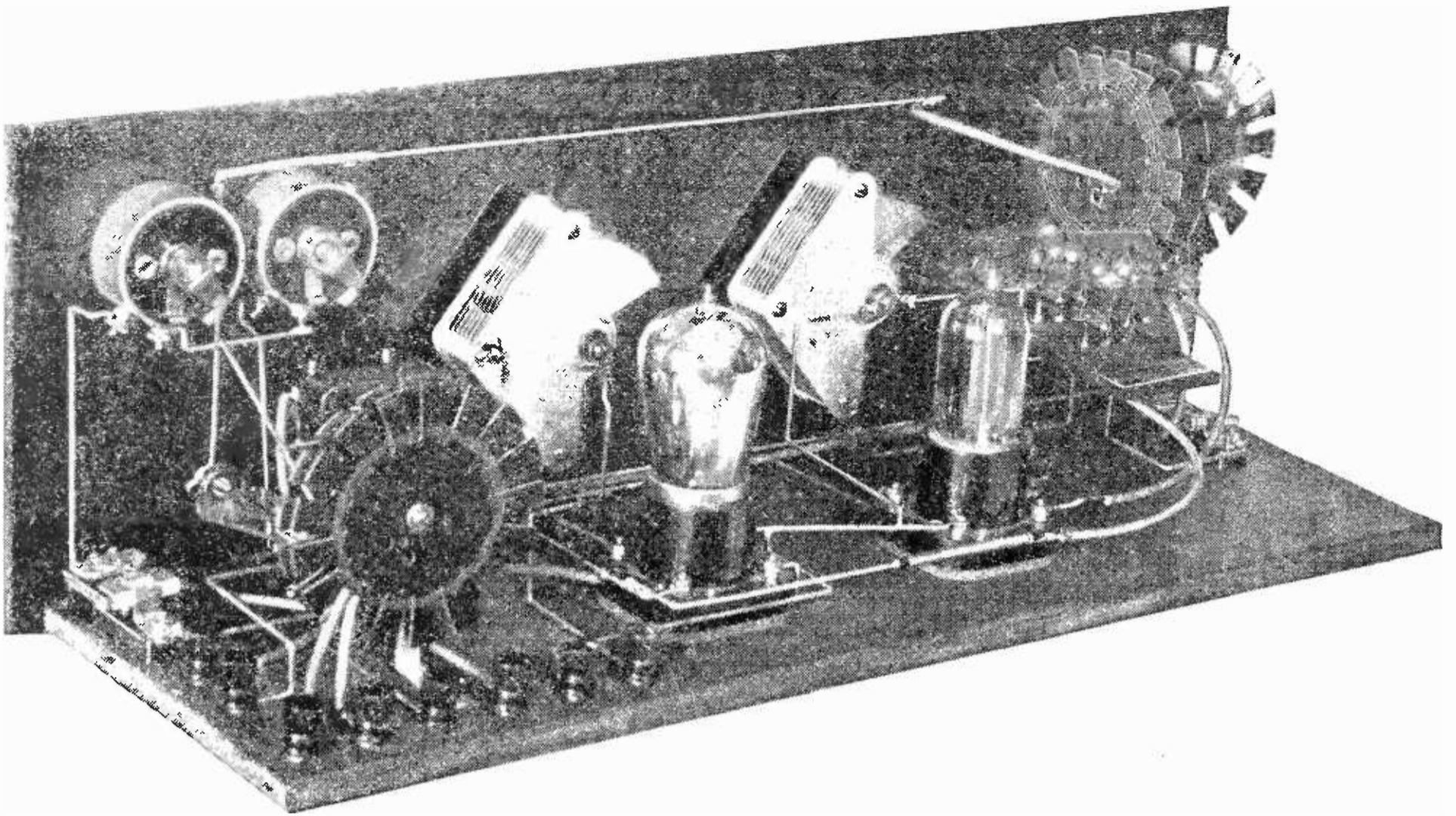

FIG. 6

The mountings for the Micadons and the combined grid leak-condenser mounting permit the clipping in and out of different values. This is desirable in the preliminary adjustment of the receiver

in an order the reverse of that usually employed, the antenna inductance and C_1 begin on the right, following up to the tickler on the extreme left. This best suits the operating convenience at station 2PI, where the antenna switch and sending key are operated by the right hand and placed to the right of the receiving apparatus. The relay operator should consider these details, employ his own ingenuity, and vary the construction accordingly.

GENERAL INSTRUCTIONS

THE operation of the set is similar to that of the ordinary regenerative receiver. The three controls, C_1 , C_2 , and tickler, are quite analogous respectively to primary, secondary, and regeneration on the old and comparatively inefficient receivers.

Tubes

Your favorite detector and R. F. amplifying combination will work successfully. As will be seen in the photographs, the author employs the UV-201-A type in the amplifying circuit, and a Western Electric J tube as detector. It should be mentioned that only the modern low capacity amplifying tubes, such as the UV-199, the UV-201-A and the correspond-

ing Cunningham and DeForest tubes, can be used in a short-wave amplifier circuit.

Wave Range

Using twenty-five turn secondaries as recommended the set will probably cover the stipulated range bounded approximately by 1400 kilocycles and 3000 kilocycles. The exact wave possibilities of the receiver are best determined by the use of a transmitting wavemeter, or a standard semi-short-wave receiver, such as the Grebe CR-3, on which the oscillating frequencies are approximately known. The wavemeter or former receiving set should be made to oscillate at 1500 kilocycles and the beat-note produced at a neighboring frequency on the new receiver. This will be quite high up on the condenser C_2 scale. Now tune down for the second harmonic which will be found exactly on 3000 kilocycles. If difficulty is experienced in attaining this higher frequency, wire is removed, turn by turn, from the secondary of T_2 until the harmonic beat-note is easily tuned with a few condenser degrees to spare. It is a simple matter to secure any desired high frequency by tuning for the second harmonic of a known lower frequency.

Wire should also be removed from the se-

condary of T_1 , until condenser C_1 tunes to resonance at about the same dial reading as C_2 .

Coupling

The coupling between P and S of T_1 is close, the two coils being separated by about one-half inch. In the case of the writer, similarly close coupling between P_1 and S in T_2 has proved more efficient than the loose coupling recommended by Mr. Roberts on the higher frequencies. The tickler coupling will of course vary with the degree of regeneration desired. In receiving continuous wave signals, the coupling should be loosened to within a few degrees of where the oscillations stop.

The Neutralizing Capacity

The primary adjustment of C_3 is made to determine the setting at which the amplifying tube refuses to oscillate over the entire frequency range, a capacity that is seldom critical and which permits considerable leeway. A second and more exacting adjustment should be made during transmission of a near-by and powerful station to discover the point within the neutralized area where the incoming signal ceases to induce a howl.

Final Adjustments

In all cases it is desirable to experiment with the values of C_4 , C_5 , the grid condenser and grid leak. To facilitate this, Daven mountings have been used by the author for clipping in these parts. Two condenser mountings are

necessary for C_4 and C_5 , and a combined condenser-leak mounting for CR. C_4 affects the stabilization of the amplifying tube, while the correct values of C_5 , the grid condenser and resistance for individual tubes, regulate the action of the local regenerative and oscillating circuit. These last values should be adjusted until the detector circuit goes into and out of oscillation over the entire range, smoothly and without howling.

Antenna

A special antenna will seldom be required for the operation of the short-wave set. It is used by the author on his double cage, fifty-five-foot L transmitting antenna.

A CONCLUDING WORD TO THE AMATEUR

REGARDLESS of the appeal to the experimenter, the transmitting amateur will find the receiver we have described particularly adapted to his own very exacting requirements. Passing over its great sensitivity and perfect wavelength range as being obvious and understood by the relay man, we desire to emphasize in closing the truly remarkable selectivity of this two-tube set. Key-click, excessive ripple, and other disturbances from near-by faulty transmitters are reduced to a most gratifying minimum. At 2PI little difficulty was experienced in copying a DX station through a local 50 watt rectified A. C. C. W. transmitter located less than one thousand feet away, both stations oscillating within four kilocycles of each other.

B-BATTERIES FROM YOUR LAMP SOCKET

CONSTRUCTION details and complete diagrams of an arrangement which will permit the use of 110-volt alternating current to supply the plate potential on any receiver up to an eight-tube super-heterodyne will be printed in an early number of this magazine. The building of the device is not difficult and it can be made for about \$25.

RADIO ON RUM ROW—

How it Makes Life Bearable for the Bored Bootlegger—and Helps His Business.



By James C. Young

LONELY, mate? Why, this ship is so lonesome that a man would begin talking to 'imself if it wasn't for the radio."

We were leaning over the rail of a rum runner, as dirty an old tramp as ever slipped out of London on a dark night. Just now she was swinging to forty fathoms of chain off the Long Island shore. With a rainy sky above and a gray sea below, heaving underneath our bow, it was a day to make one think of a stuffed chair and a cheery fire. But this particular rum runner—call her *Augusta*—had been standing up and down Rum Row four months and not a man aboard had stepped on dry land. Add two weeks for the first trip across, with perhaps another month off shore, and yet two weeks more to cross again. Then we get a new conception of what it means to be lonesome.

"Nothing to do at all," said the big man in the blue sweater, standing at our elbow. And the gray eyes in his burned face looked forlorn.

"Once Hi was wrecked in the Hindian Ocean and lived a month on some bloomin' crabs, but that was an heasy berth alongside this one. We just lay 'ere, rotting our 'earts. It's no life for a sailor. What they need on these blarsted ships is dummies, not men."

"Why don't you go ashore at night and stay a while. Surely there isn't much danger?"

"Danger enough, mate; not that Hi mind, but the old man wouldn't stand for it. 'E lost one hofficer that way. What do you suppose? The fellow was a drunkard and couldn't stay sober ashore, even when 'e'd been on a rum ship three months. So this blighter gets 'imself locked up and they deports him as a halien who 'ad no right to be

in your bloomin' country. And 'e couldn't tell where 'e came from.

"No; the old man wouldn't let me go. And if Hi went the crew would want to go, too. The only thing we can do is listen to the radio and wait for the boats to come out. Hi'll never

What?—No Romance?

The certainties of modern existence have not yet eliminated all the romance from life, as readers of this very interesting article by Mr. Young will agree. The author has had the very unusual experience of visiting the liquor smugglers in their own haunts, "somewhere on the Atlantic" outside the 12-mile limit. Though the business of the hardened crews on these ships is supposedly continuously exciting because of the risk and danger involved, the men, it seems, are actually bored to death. And right there is where radio is helping to lift them out of themselves. You will enjoy reading what broadcasts do for the outcasts.—THE EDITOR.

make another rum cruise. Why, one fellow up for'ard started to knit 'imself a sweater, like 'e'd seen 'is mother do. It was 'orrible the way 'e swore over that sweater. And Hi says that a ship where sailors begin to knit is no bark for me to sail on."

By way of consolation for the *Augusta's* first officer, we suggested reading as a cultural and diverting influence.

"Read?" he repeated, and paused to sink his anchor teeth in a new square of London plug-cut; "why, mate, Hi've read every book in the old man's locker, from one called *Surgery at Sea* to another—well, you could never guess what Hi found in that locker."

"*Romeo and Juliet*," we suggested, at a chance.

"No, no, matey, something worse. It was all about a man who 'ad some s t r a n g e hideas. 'E was called a—well, now, what did they call him?—Oh, yes, Pilgrim. The book was *Pilgrim's—Pilgrim's—*"

"*Progress?*"

"Right-o, *Pilgrim's Progress*. Well, Pilgrim was an odd one, Hi will say. 'E stopped me from this reading you talk about. The only fun we ever 'ave is the radio."

"So you like it, then?"

The first officer's face broke into its first smile.

"Hi surely do," he said, "and as for the men, we couldn't keep them aboard without it."

RADIO GAMBLING—A NEW THRILL

WHY, every night, they are lined up to get their turn at the 'ead set. Do you know what 'appened on this bloomin' ship? They

started gamblin' in the fo'castle, stakin' their turns at the radio when money gave out. Hi found one little tike who 'adn't been able to listen-in for a week, 'aving lost all his chances. So I 'ad to stop that radio gamblin'. We'd 'ave 'ad a mutiny some night when there was a big concert."

"What do the men like best?"

"Oh, anything; mostly the jokes and those songs about 'ome you Hamericans are always singin'. Do you know (and he laid a confidential hand on our arm) Hi 'ave an hidea that

this lonesome job makes a man think about 'ome more than he would. Now, as for me, Hi 'ave a good woman and a young one, too, back in Lunnon and sometimes at night Hi get to thinkin' about them mighty 'ard. You know, matey, we just drop our hanchor here and begin to rot. It puts a man in a blue funk, before long. And when these radio

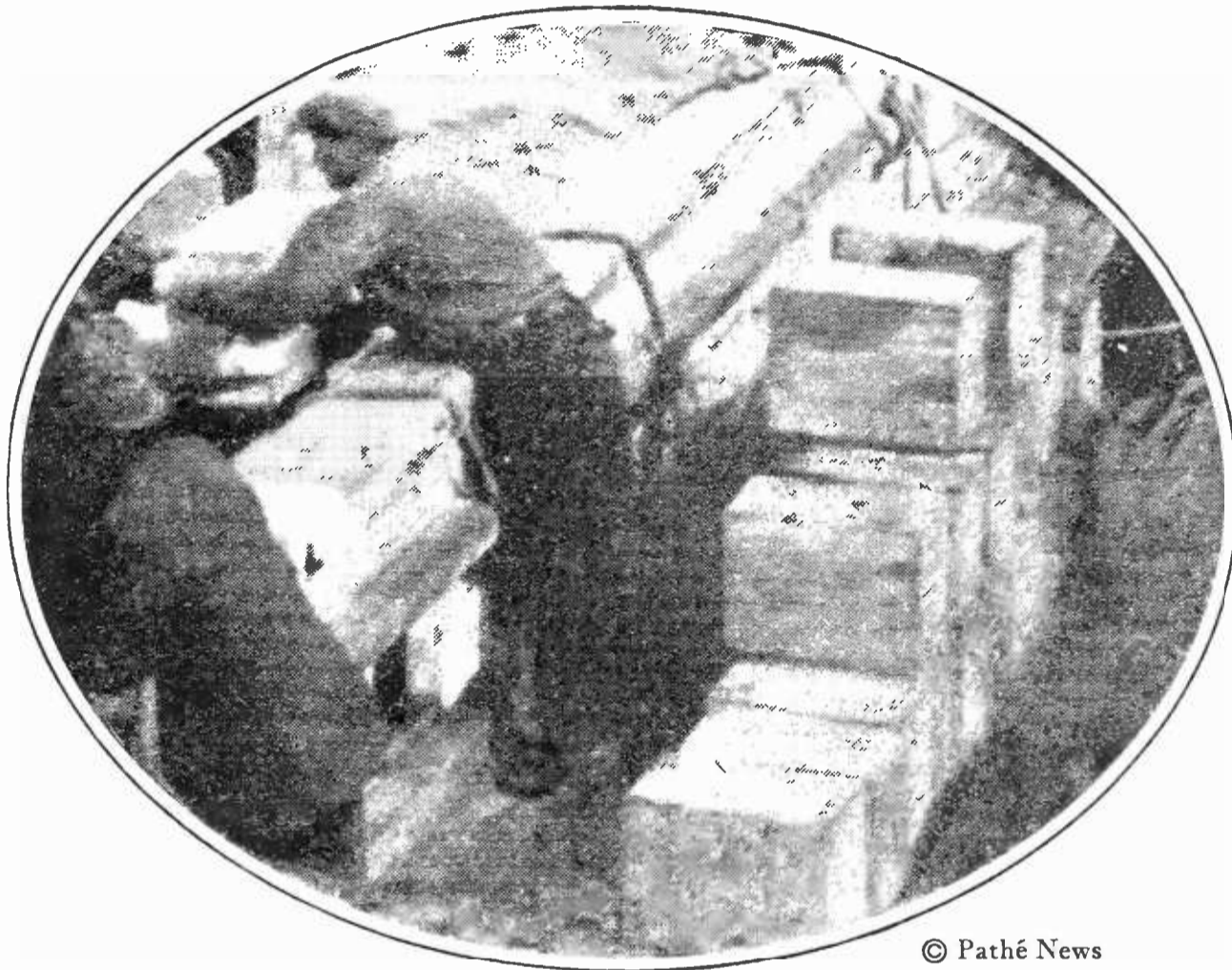

© Pathé News

"WHAT'S YOUR ORDER, PLEASE?"

There is more speed than ceremony involved when the bootleggers supply the small boats which come out from shore to lighten the load of the marine merchant. It is apparently as easy to hand a case over the side as it is for the milkman to come up your domestic back steps with his wire basket full of bottles (milk)

singers of yours start to sing about little 'ouses with the bloomin' roses a-twining all over them, a man kind of wishes he 'ad one and didn't 'ave to go rum running."

"Do you get many stations on your set?"

"Oh, yes, most anywhere. You see, we 'as to 'ave a 'igh-powered set; but of course you know I must not talk about that. We 'ave 'eard a lot of stations, dozens of them, I would say. 'Ere, lad, how many stations do you reach?"

His hail brought over to us a young fellow of about twenty-five, the radio operator. He had a coat with brass buttons, a cap of naval cut, and looked like a man who had seen service. Despite the rough-and-tumble life on a rum

runner, he kept a straight back and a smart salute.

"We can hear almost any station within fifteen hundred miles," he said. "Of course we get WJZ and WEAJ every night, along with many other stations near by. I don't know what the men would do without our radio. All of the big rum ships carry sets now, partly for the men and partly—well, you understand. Even the schooners are rigging up antennas. Before long the whole fleet will be equipped to receive long distances and many of the ships can send as well. Would you like to see our radio room? It's all right, isn't it, Mr. Jamieson?"

"Oh, sure, lad, lead away."

We went forward, past a bulwark of cases standing breast-high, which several of the crew were handing up from an open hatch for the night's trade. The *Augusta* had sailed with 50,000 cases of Scotch and brandy and still had about one-fifth of her cargo below decks. She was a 5,000 ton tramp steamer, and save for her dirt, not unlike any other tramp. But surely this was the dirtiest ship afloat. Jamieson had the bearing of a real sailor and a sailor of the pure breed will not tolerate dirt aboard his ship. So we wondered—but just then the Captain appeared, and the dirty ship was explained. He had a bleary, rum-soaked face, a heavy, red jowl, with a fringe of gray hair beneath a sou'easter. His clothes matched his face and he bestowed a glance upon us that fell like a blow.

Perhaps it should be said that us included the writer and another man. By a special dispensation obtained through this other man we had come aboard the *Augusta* about noon of a murky day. She was twelve miles off shore, maybe fifteen, and her Captain had said that he would do us the honor of permitting a visit.

We recalled that excellent rule, never to speak in some places until you are first addressed, and waited for the Captain to have his say. It was brief enough. He nodded, remarked that it was a "Rotten day," and went aft with his glasses to study the shore. Judging from the growing bulwark of cases, customers were expected.

IN THE HEART OF A RUM RUNNER

THE radio man disappeared down a ladder and we followed after, right into the heart of a rum runner. And there, in a little corner of his own, he presided over a magic key and receiving set which kept the *Augusta* in communication with a large part of dry America.

"What's in the air?" asked Jamieson, and the edge on his voice revealed the true radio lover, always expectant of something to stir the spirit.

The radio man—Edwards—did a few tricks with his instruments and looked up. "Somebody speaking at a luncheon," he said, "all about foreign trade and America's part—"

"Aw, blarst that stuff," exclaimed Jamieson, "why do they let 'em do it! Try hanother station, will you, Eddie?"

Eddie tried and presently connected.

"Springfield, Mass., sending out a minister's address at some meeting there. Hello, what's that? Oh, he says the dry law must stand and prohibition is an accomplished fact. He wants the President——"

"Stow it, stow it, Eddie," pleaded Jamieson, the barometer of his expectation dropping painfully. "Can't you get us a song or two, lad?"

It was evident that we had come at the wrong hour really to enjoy a rum runner's concert. While Eddie searched the ether for a song—and we suspected the first officer of wanting a sentimental song—there was opportunity to take stock of the radio room. Why it should be below decks instead of above was not apparent, except that the *Augusta* had been built long before radio was known and there was no provision for quarters. But seemingly this did not influence the ship set because Edwards said that he could reach practically any desired point in the Eastern or middle States.

"No songs, Mr. Jamieson," he remarked, "but here is another speaker. Wait a minute; he is going to tell a joke."

"Let me hear, please," cut in Jamieson, and deftly took the set. But in another minute he flung it away.

"Your Hamerican jokes are worse than ours



TYING UP ALONGSIDE A RUM SHIP

at 'ome," he said, "Hi 'eard that one in the music 'alls when Hi was a boy."

RUM SMUGGLING UP TO DATE

WITH that, the first officer started up the ladder and we reached for the set, just in time to hear the laughter. Edwards obligingly did his best to tune-in something worth while, but the only themes in the air were luncheon speeches and weather reports.

"Maybe you can stay over to-night," suggested Edwards, "when the big stations go into action. There is a concert scheduled at WJZ, with an Italian prima donna on the bill. We have a fine set and you will get a treat."

"We certainly would like to stay. How about the Captain?"

"Well—that's so, but it will not do any harm to ask."

"How long have you been aboard this ship?"

"Oh, I just signed on for this cruise, and it's my last one. I came for the money, forty pounds a month, but it's no fun lying here with nothing to do. Our radio is the only thing that cheers us."

"Do you have a good deal of business to handle, too?"

"Well, I am not supposed to discuss that, although your legal people must know about our radio trade. You see, the big dealers in New York often send us orders by wireless and we have the goods ready for their boats when they come alongside. That saves time and reduces the risk of being seen. It also enables the shore boats to pay for their goods on land, without running the chance of hi-jackers robbing them

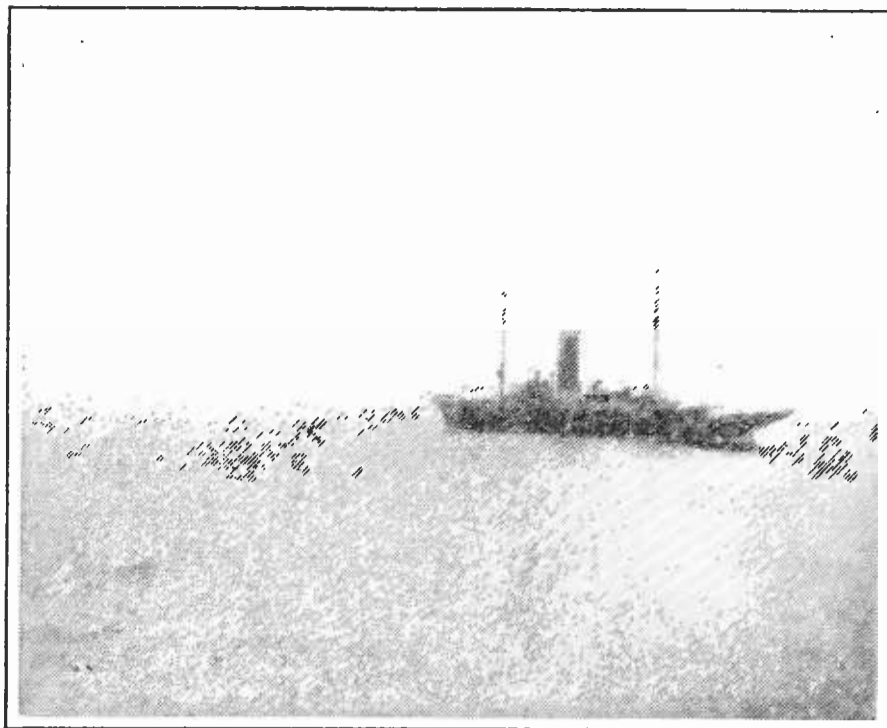

FASTEST OF ALL THE LIQUOR RUNNERS

Is the steam yacht *Glasgow*, whose trim lines and saucy bow indicate that she could run away from almost any of the liquor patrol vessels now in commission

somewhere on the way out. A lot of money has been lost that way. Why, I remember one poor blighter who came aboard without a cent; they took \$10,000 from him less than a mile away."

"Can't the government agents trace your radio connections ashore?"

"That is a hard thing to do," answered Edwards. "Long Island and New Jersey are full of antennas. It would be almost impossible to find all of them. And we do not have to establish connections with such near-by stations. We can take an order from Chicago just as easy as from anywhere else," he wound up with a wink.

"Of course those orders are in code?"

"Oh, yes, everything we send or receive is in code. A thousand sets might receive an order without understanding it. Then we are always interested in the weather reports. Your storm warnings give us a chance to prepare for a big blow. This spring we had weeks of bad weather when the boats could seldom come out. And we were blown all up and down the coast, sometimes dragging our anchor for miles, in order to stay close in shore. It got so bad several times we had to heave the mud-hook and stand out to sea. One schooner was lost altogether and several ships parted their anchor chains."

"Well, your pay is good, any way."

"Yes, the pay is what gets the crews. Fo'-castle hands are drawing twenty pounds a month, when they would be lucky to get six or seven on any other ship. Even then it is hard

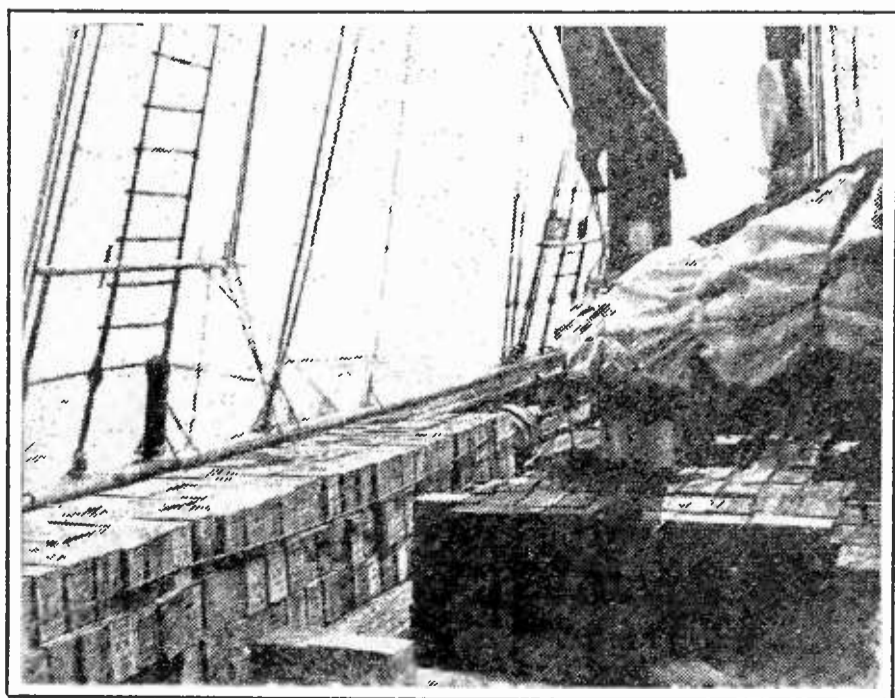

© Pathé News

TEN THOUSAND CASES

Are stowed in the hold of this ship. Very few are empty

to sign men for more than one trip. I don't believe the big ships really could keep their men in hand without radio sets and free allowances of rum. Sailors are used to long voyages, but they dislike especially lying idle in one place. Occasionally the men get so anxious for something to do that a few of them land in one of the small rum boats and stay for several days. But since we lost an officer——"

"Yes, the first officer explained that."

"Well, the old man has shut down on shore leave for everybody and we are cooped up here like prisoners."

"Do you have any trouble with the crew?"

The radio man arose before he answered and looked up the ladder. Then he came back and said in a half whisper:

"There is more than one hell ship in the fleet. Most of these skippers are hard customers. They wouldn't take such a command, with a chance of getting into trouble and losing their papers unless they got big pay. And the cargo owners have a difficult time chartering a ship with a captain worth while. Many of these ships are tubs that have been rusting in Liverpool docks for a long time.

"As for crews—well, some of the fellows are the devil's own. Others are not so bad, real seamen who sign for the pay. Once in a while there is trouble. Our skipper carries a gun night and day, especially as he is the man who handles the money. But Mr. Jamieson is worth any three men aboard with his bare hands. They don't talk back to him.

"On one ship they had a mutiny not long ago over the allowance of rum. The men are mighty lonesome and the rum cheers them up. Then they want more and more until they really get ship blues and insist on going ashore. The captain in this case refused and they had a fight that lasted a half day. The officers didn't want to shoot, fearing they would have to begin killing in earnest if a pistol ever cracked. So they went for the men with marlin spikes and the men went for them. It was about a half dozen against twenty, but they stood off that crew and somehow kept them from the liquor until the captain got things in hand."

"Why didn't the other ships send help?"

EVERY MAN FOR HIMSELF ON THE RUM FLEET

"IT IS a case of every man for himself out here," said Edwards. "We were down near the Highlands when this row took place off Montauk Point and I only heard the details second-

hand. But other skippers would be afraid to interfere because their own men might start trouble. These fellows get hungry-eyed, watching all the money come over the side, and I would not be surprised if they seized some of it."

"Has that ever happened?"

"They say two ships have been deserted off shore, officers and men splitting up the money aboard. But I don't know. You can hear almost anything out here. Still—I wouldn't doubt it."

"And you think the radio helps to keep crews in good humor?"

"No question about it. Unless there are boats to be loaded we have men down here as long as there is anything to be heard. They are like a crowd of boys, eager for something funny. And they have a fancy for your songs, too. Opera is a little out of their range and speeches are not popular. We have heard so many programs in the last four months that we almost know the regular performers as old friends. Some of them go from one station to another and others appear regularly at a single station. I have heard that most of them are unpaid. Why do they do it?"

"Often they are stage people and need the publicity."

"Well, they certainly get it. I know some of their voices so well that I never shall forget them. Usually we can hear splendidly and I suppose that, having nothing to do, we concentrate on the radio more than people ashore.

"Sailors have a lot of odd tricks. Men who stay on a ship for months are likely to become a bit queer. The captain's boy—mess boy, you know—has a record of all the songs and singers he has heard and the bands and selections played since we first cast anchor off this coast. I don't know what he expects to do with that list, but he spends hours making additions, checking it up and talking to himself about it. You should see some of the spelling—whew!"

"How many ships are there in the rum fleet?"

"Anywhere from seventy-five to a hundred. Some of them only make one cruise and find that it doesn't pay, especially the tramps. A big vessel like this one can easily carry fifty or sixty thousand cases. Unless the owners have connections ashore which assure a ready sale, they lose money through insurance costs, pay for the crew and general upkeep. The schooners, with ten or fifteen thousand cases,

have less expense and sell out in time to make a fine profit. But a big steamship with fifty thousand cases, sold in small lots, must stay here for months to clear her hold.

"That is the trouble with us. We brought too much, struck bad weather, and I guess our shore agents have failed us. Sometimes, when your bootleggers find out that we are heavy laden and anxious to sail they will not buy, but force us into a corner and then get the liquor for almost nothing. One ship sold 10,000 cases at \$10 each in order to get away. The steamships which make money are those operated by big companies that begin to unload the moment they arrive. Some of these sail inside of two weeks."

"ALL VISITORS ASHORE"

"HOY, radio room," called a voice down the ladder and we went outside to see Jamieson above. "All 'ands ashore is the captain's order," he said. "You better get started, young fellow."

"Now, that's too bad," remarked Edwards, "I'd hoped you could stay over and share our mess to-night. Then I would have showed you what we could do with our set."

"Maybe the Captain—"

"I'll ask him for you," said Edwards.

But the moment we placed foot on deck it was apparent that that request would be out of order. The Captain was hustling his crew around and the cases were coming up faster.

There looked to be at least a thousand on deck, bearing a well known name—White Horse. Our boat awaited and the leader on this expedition stood at a ship's ladder—made of rope—dangling over the side. He nodded and we stayed not on the order of going.

"Next time, come late in the afternoon," whispered Edwards, just as we started over the side. "Then you can stay and hear a concert."

We promised and shook hands. Even the Captain granted us a perfunctory salute. Evening already had fallen and the chill of a wet night laid hold of us. We took a last hasty look around and thought again of the snug radio room and the concert we were about to miss. Also there would be warm food when the ship's bell rang again, and other cheer to comfort the heart.

Against all of these advantages, an open boat awaited just below our heels and the two men in her were saying for a third time, "Come, hurry up."

So we hurried, but paused yet a moment to say our last farewell.

"I am coming ashore soon. And I 'opes by that time to hunderstand better your bloomin' Yankee lingo," said Mr. Jamieson. "You may strike me pink, but I cawn't make out the 'alf of it, mate, and that's the truth. 'Eave away."

The motor sputtered and we fell away from her side on the next wave, into the night, taking every 'eart on the rum runner with us—an unseen cargo.

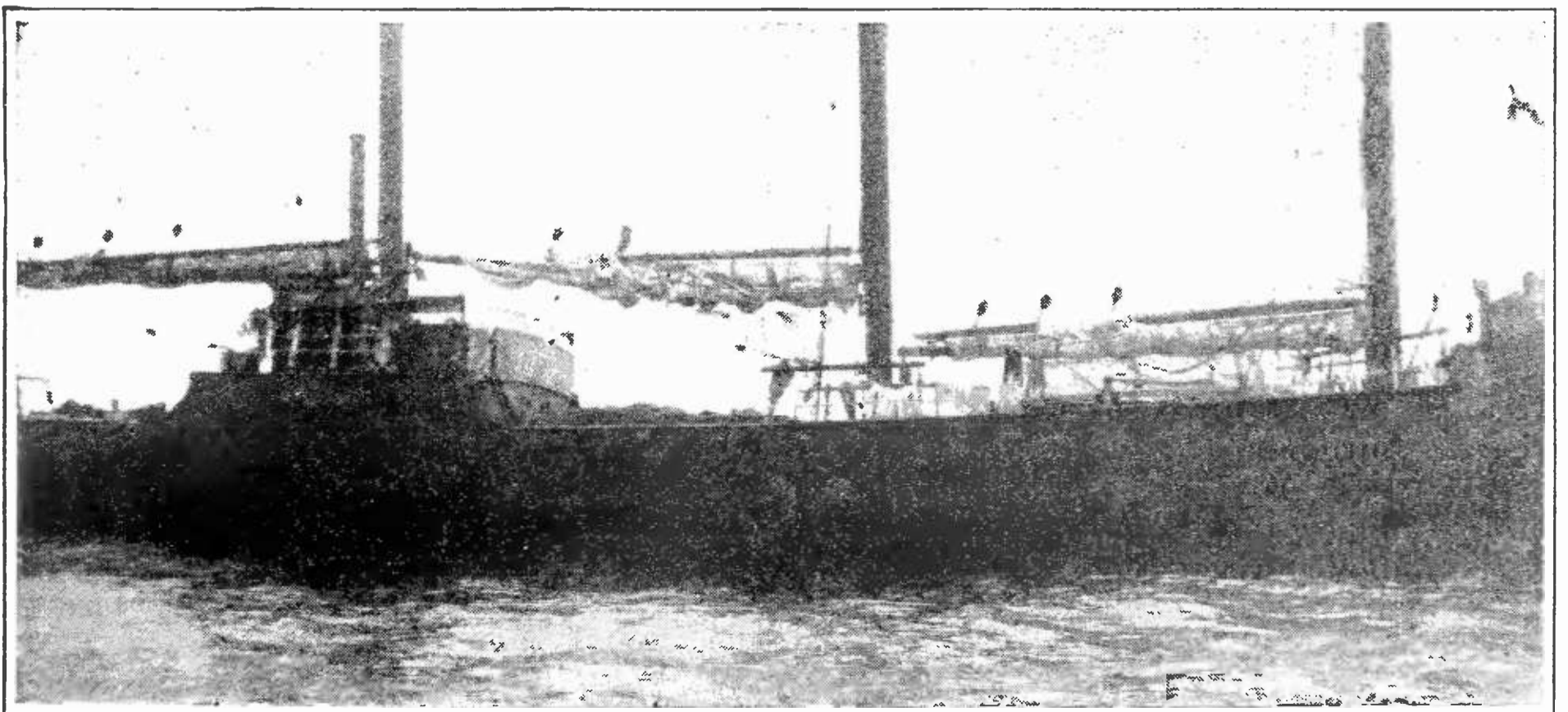

WASH DAY ON THE RUM FLEET

The S. S. *Rusk*, riding at anchor off Long Island. This is one of the ships Mr. Young boarded on his visit to the forbidden fleet

The Way of the Transgressor

What the Common Deceptions in Radio Advertising and Selling Are—
How the Novice May Recognize Radio Misrepresentation or Dishonesty

BY WILLIAM P. GREEN

Associate Director, National Vigilance Committee, Associated Advertising Clubs of the World

Radio dealers with more knowledge of what they are pleased to call "sales methods and sales push" than of the actualities of radio, commit many crimes of which they are perhaps, quite ignorant, by the exaggerated claims they make verbally and in their advertising. The radio innocents accept these irresponsible claims and then there is trouble. Mr. Green describes a clever deception in the private sale of "factory built" receivers, "sold at a sacrifice." He is well qualified to write on this subject of deception in advertising, since it is his business as an official of the Associated Advertising Clubs of the World to trace fraudulent and deceptive advertising.—THE EDITOR.

DRIFTING through the classified advertisements of a daily newspaper in any one of a hundred cities in the United States, it would not be at all out of the bounds of possibility to find an advertisement similar to the one reproduced below.

"FOR SALE AT A SACRIFICE—Standard make, three tube set; tubes, A and B batteries, two sets of ear-phones, and non-power loud speaker, all in excellent condition. Call after twelve, 1542 Hudson Boulevard, Apartment 14."

Since you are interested in the purchase of a radio set, you reach the apartment around the middle of the afternoon. It is the usual, attractively furnished home of a person in fairly good circumstances. A middle aged woman answers the bell, and when you inquire if the one who advertised the radio set is in, she bids you enter to be seated a moment while she calls him. You find several minutes on your hands to look around and, of course, you are attracted almost immediately by the radio set on a table in the corner. You step over, lift the cover and observe the interior. It seems to have the appearance of a well manufactured instrument.

As you turn a dial, the door is opened and a middle aged man walks in. He introduces himself as the owner of the set and explains that because of business difficulties, he is

under the necessity of leaving the city immediately and, consequently, has offered the set at a sacrifice. His statement that he has had the set and equipment only a few weeks seems to be borne out by their fresh appearance. On the whole, the outfit would seem to be a bargain and after some questioning you agree to take it, provided it works when you return in the evening at a time when local stations are broadcasting. The test in the evening proves satisfactory and by nine o'clock you are on your way home in an automobile with the set and accessories beside you.

Now comes the next day and with it the second act of this radio drama within the apartment. The man to whom you talked yesterday enters the same room, carrying the same type of radio set. His wife follows with several boxes containing tubes and a couple of pairs of ear-phones over her arm, all looking so much like the accessories you purchased yesterday that you easily would have mistaken them for your own. Within fifteen minutes the set is hooked up, and the tubes are in place, with the ear-phones carelessly placed over the back of the chair as though the owner had left them there after listening the night before.

The explanation of this situation is that instead of being under the necessity of leaving the city because of business difficulties, this man and his wife are in the business of selling radio sets and equipment, which they purchase from some fly-by-night manufacturer and sell to the public at a profit. They are following

the practice which, for years, has been a menace in the furniture and music business. Among the trade they are known as "gip" residence dealers. No sooner do they sell a set and equipment to one person than a similar outfit is brought up from the cellar and put up in its place. The appeal of the sacrifice offer, with the added atmosphere of installation within their home, enables these people to do a substantial business.

PUBLIC CONFIDENCE IS BEING UNDERMINED BY
DECEPTION

THIS is one example of abuses to be found in radio merchandising and advertising to-day. It is among the more extreme practices of deception, and those which are to fol-

the effects of which will be felt even by the more reputable manufacturers and retailers.

It is a well known axiom that a counterfeiter always copies something of value. When a new field opens up, and particularly one like radio, which has enjoyed a mushroom-like growth, the faker soon appears on the scene to capitalize the success of legitimate industry. The public suffers, the honest merchant is placed at a disadvantage, and the industry as a whole shows increasing evidences of deceptions that undermine confidence.

We have an excellent example in the manufacture of tubes, for particularly in recent months has there been a marked increase in the number of tubes designated as "201-A" by concerns which are appropriating an identi-

**Why Serial Numbers Are Used
and
Why We Remove Them**

Every neutrodyne set has a serial number either engraved on the panel or fastened inside the cabinet. By this means manufacturers have been able to keep track of every set leaving their factories, and where necessary, have traced sources of supply. In our efforts to protect the public from being overcharged and to protect the wholesaler who sells us from "getting in wrong," we have removed every serial number from every neutrodyne set in our stores. The result—our source of supply is not cut off and the public benefits by our low prices.

ATTENTION!!

Receivers bear a serial number engraved on the panel. If this serial number is effaced the sets are considered defective and are not the latest improved instruments, guaranteed by us. Beware of purchasing apparatus from unreliable sources.

Look for the name and the serial number engraved in white letters on the panel. This is the only way to identify a genuine factory built and factory guaranteed receiver.

BOTH SIDES

These two pieces of advertising copy, one, that of a retailer, and the other that of a manufacturer, appearing on the same page of the same newspaper, show the bitter fight being waged between the manufacturers of sets and the cut price stores

low should not be considered equally flagrant. Of course many honest people have occasion, in emergency situations, to sell their radio sets at a sacrifice. What the consumer public must determine in each instance is whether the offer is bona fide. The fact is that little tricks of deception and misrepresentation, even though many of them do not constitute actual fraud, are undermining the confidence of the public in radio merchandising and, if uncontrolled, eventually will prove a boomerang

fication mark which the public has come to associate with the product of the Radio Corporation of America. The danger is that new customers, unacquainted with radio equipment, who have been told that the "201-A" is what they need, may have the cheaper product foisted on them without knowing it.

Perhaps the next most flagrant deception being practiced on the public is in the sale of parts, or sets manufactured from parts, which are sold to the public under the Neutrodyne

“Greatest Sale in History”

“Lowest Prices in the City”

“We Undersell the World”

“Our Prices are Lower”

“Price Reductions Hit Bottom”

“Unequaled Radio Bargains”

“Trade With Us—Greatest Savings”

“SOMEBODY’S WRONG”

Seven leading headlines from the advertising of seven radio stores on the same day in the same city. Somebody must be wrong

trade mark. What happens is that a store purchases licensed parts, which go into the building of a Neutrodyne receiver. They take these parts and through the addition of others, perhaps of inferior quality, build a set which is then advertised for sale under the name of the manufacturer of the parts. The danger in this practice is found in the fact that the manufacturers of parts also manufacture sets.

The writer has tested this out many times to see how it works. For instance, companies like Freed-Eisemann and F. A. D. Andrea manufacture Neutrodyne parts and also complete sets. Frequently I have entered a store in response to an advertisement for a Freed-Eisemann set and found that what was on sale was not a factory manufactured instrument, but one which had been built in the store from certain parts manufactured by the Freed-Eisemann Company, which, however, was being sold in the cabinet as a Freed-Eisemann set. This is unfair to the radio novice because, having heard of this or some other particular set, he may be led to believe that he is getting a factory built machine when such is not the case.

MANY ADVERTISEMENTS ARE NOT QUITE HONEST

RECENTLY I undertook to study a cross section of radio advertising by taking the columns of magazines and newspapers appearing within a week’s time in order to determine to what extent exaggeration and deception may be prevalent from the standpoint of the consumer public. The result shows certain outstanding characteristics which, in the opinion of the writer, can only eventually thor-

oughly dissatisfy the public. Most of the statements examined are not such as to constitute a type of misrepresentation or exaggeration which could be prosecuted. They merely lead the purchaser of a set or equipment to expect more than he actually gets, in some cases much more than is even possible from the standpoint of present technical development.

Too many manufacturers of radio sets picture the ideal rather than the actual. Take, for example, a statement such as this:

When the dial setting for any station has been determined, that station will come in on its own setting any time.

As against this, it is well known that distance reception is most uncertain, depending on the time of day or night, weather conditions and other variable considerations. The purchaser of a set who gets a station fifteen hundred miles distant to-night and cannot bring

Precision Performance

Having once brought in any station and charted the dial positions, that station may be brought in at any time at the same dial settings—any time to-day, to-morrow, or a year from now. The set works like the combination of a safe and operates with equal certainty and precision.

IT CAN’T BE DONE

This type of advertising leads many purchasers of sets to expect more from them than is possible in view of changing weather conditions, differences in the range of daytime and evening reception, and other controlling factors

it in at all to-morrow night wonders why, and well he may, in view of the representations made to him in the advertisements. Over a period of months he must learn that a radio set cannot be operated with the precision of a phonograph, as some manufacturers would lead the public to believe. Another representation that a set offers “perfect mastery of radio” is a bubble bound to burst after the purchaser has endured an evening full of the trials and tribulations which the experienced operator has come to take as a matter of course.

Then we find the advertiser of equipment who endeavors to trace all radio troubles to the fact that the product of some competitor is being used rather than his own. He says, as one dealer did recently, that one hundred per cent. of all automobile trouble is in the ignition,

and that the same is true with a radio set. If the trouble is noise, it's the batteries. Weak volume, blame the batteries again. No distance, likewise blame the batteries. If the unthinking customer responds to this advertisement, buys the particular battery and the noise continues, because it comes from some entirely different source, satisfaction cannot result.

Discontinued sets and equipment frequently are advertised as possessing full current value. For instance, in Chicago, much advertising was recently published of a Radiola model now in the background because of the newer types being manufactured. It was offered with the statement "List Price, \$162.50—our price \$37.50." At one time this set sold for \$162.50, but it does not have such a list price now, and it cannot have anything like that value to the purchaser to-day when compared with more up-to-date sets. Experienced radio buyers who keep closely in touch with developments can hardly be deceived by such reductions; but the constantly increasing number of new buyers are easy prey to misrepresentation, which tends toward the growth of a substantial group in our population who eventually will condemn radio because they will conclude that its products are not marketed with fairness to the public.

It has become a rather common fault to advertise sets at a certain price and in such a way that the reader may well believe that full equipment is included. If he decides to take the set, he places his money on the counter, only to find that an additional outlay is required before his radio is equipped to operate at all. His reaction is likely to be unfavorable to that dealer. We have seen some advertisements which would seem to indicate a deliberate intention on the part of advertisers to list equipment in such a way as to lead the reader to believe that it is included in the price quoted when, however, the price given covers only the set itself.

The public may well inquire when shopping for radio sets in response to advertising whether a set has its weak points as well as those good points which have been emphasized by the manufacturer. Ease of operation and the different steps necessary to bring in stations may be featured, but in doing so some particular adjustment, which actual operation shows to be both critical and more or less unstable, is not mentioned.

WHY ARE SOME DEALERS SO OPTIMISTIC WITH DISTANCE CLAIMS?

CLAIMS of distance reception are all too often based on the exceptional rather than the average. Any one who has operated a standard set for a reasonable period of time knows the folly of exaggerated claims of this sort, and yet many a set has been sold because the purchaser was led to believe that it would receive three thousand miles any time, any where. Such a set, operated in a nest of local stations and which cannot easily reach out and bring in broadcasting from a distance of several thousand miles, cannot be expected to come up to the hopes of the man who has been led to believe that he could bring in any station from any direction and from any distance

Columbia Neutrodyne \$140.00

Tubes
Batteries
Loud Speaker
Aerial Equipment
Ear Phones

HOW IT'S DONE

The price quoted is for the set alone although listing accessories in this way might easily lead the reader to believe that they are included

almost at will. To say, as one advertiser did recently, that "there is no limit to the range of this receiving set" is playing with distance in a way that even the most experienced operators with the highest powered sets would hesitate to do; or to say, as another advertiser has done, that a set selling for less than \$75 will do anything that any other set will do; or that with the use of a piece of special equipment, programs will come through the air strongly and clearly, not marred by any static and without appreciable effect from electrical storms, warm weather, or of radio weather of any description, may add other names to the list of dissatisfied radio purchasers.

These instances of extreme and exaggerated claims show the necessity for careful buying on the part of the public, and as the public comes to know the pitfalls, it will read radio advertising with an understanding of what to avoid. Honest advertising and merchandising are the only methods that pay in the long run.

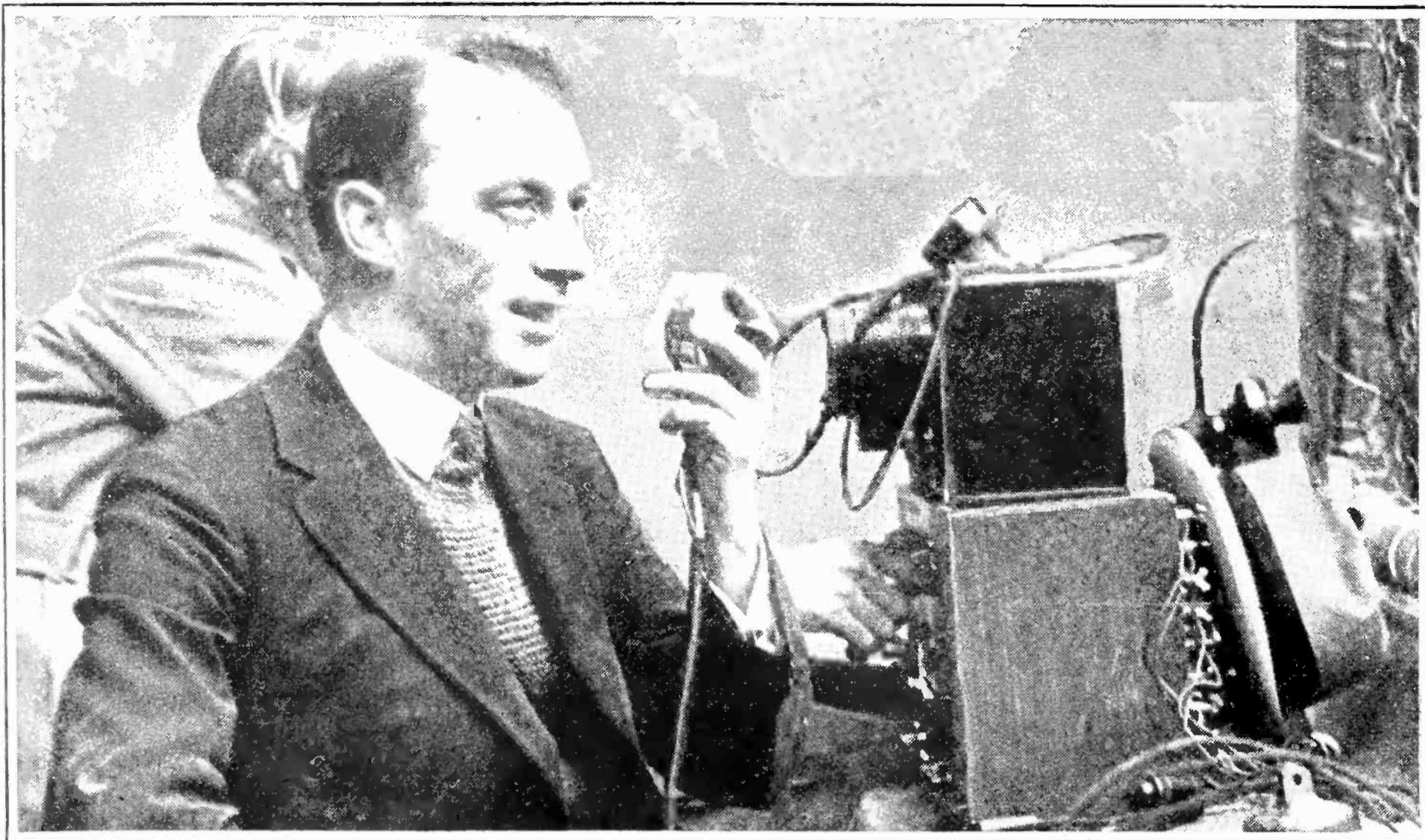

GRAHAM MCNAMEE, POLITICAL ANNOUNCER

Whose voice, directly from the floor of the Cleveland Republican national convention has been heard by millions of listeners all over the country who listened to the first party convention ever broadcast by radio

THE MARCH OF RADIO

By *J. J. Morecroft*
President, Institute of Radio Engineers

The Growing Importance of Short Waves

AS INFORMATION accumulates, the possibilities of short wave transmission seem to mount at an increasing rate. The high-frequency range, from 3000 kilocycles up, was regarded as useless only a few years ago. It was thought suitable for laboratory work such as Hertz, the radio pioneer, had carried out but of no avail when it came to reliable communication over appreciable distances.

Reliable experiment shows this not to be the fact however; some of the most reliable channels in operation over long distances to-day are using frequencies of approximately 3000 kc. and research engineers are continually gather-

ing data to show the feasibility of using even shorter waves. Pittsburgh to Hastings and London—Schenectady to California and England, both short wave channels seem to have attained a remarkable degree of reliability compared to what was to be expected.

With spark wave telegraphy, such short waves would have been of no service at all, for the amount of power which could be sent out in the form of a 100 meter damped wave from a suitable antenna would have been so small as not to reach more than a few miles. There are very important reasons why these high frequencies will do so much more on continuous wave transmission than could be obtained with

the spark transmitter. For a given wavelength a much higher antenna can be used with continuous waves than with spark waves and the amount of power which can be sent off is hundreds of times as great with the continuous waves. The decrement of the spark wave was one of its most important characteristics, so much so that it was not allowed to exceed a certain value, as decreed by law. This decrement could not be kept low using as efficient radiators as are our present short wave antenna.

With a good antenna as much as 10 kilowatts can be radiated at 3000 kc without any trouble at all and possibly much more than this will be possible when we know more about high frequency engineering. Although many experimenters report the short wave channels show less fading than those using waves several times as long, the measurements of Pickard (none better now exist) show this not to be true; apparently the fading phenomenon is about as prevalent in one channel as in the other.

With waves as short as 35 meters, a Paris amateur has succeeded in talking to Algiers; Marconi and others in England have used successfully even shorter than this and we may confidently expect to see this branch of radio of ever increasing importance.

Radio Broadcast's "Covered Wagon"

BEFORE this magazine reaches the hands of its readers, another romantic radio adventure will have begun.

Captain John R. Irwin, the man who received the first C Q D from Jack Binns on the *Republic*, who was wireless operator on that famous air expedition in Walter Wellman's dirigible *America*, who was an officer in the Air Service during the war, and later radio officer of the *Levia-*

than—is now on his way across the country in a modern prairie schooner. He is the pilot of RADIO BROADCAST'S "Covered Wagon" and Mobile Laboratory.

He is going to introduce radio to those Americans who heretofore have never known any more of it than could be learned from the perusal of newspapers, those who are not yet convinced that it is the wonderful thing we in the cities have found it to be.

Then, too, he is going to cooperate with radio clubs and power companies throughout the country in an effort to overcome the electrical noises known as "man-made static."

His "Covered Wagon" is an automobile truck with a body like the old prairie schooners. Samples of all the Knock-Out receivers, built in the laboratory of this magazine, will be on board and frequent demonstrations will be made. Captain Irwin will travel from New



PATRICK, CARDINAL HAYES

Catholic Archbishop of New York before the microphone of W E A F. His Eminence is shown holding the red hat which is one of the badges of the high ecclesiastical office to which he has recently been elevated

York to California and thence to Florida. He will make a complete survey of radio in all parts of the country and will give advice to those who are not sufficiently familiar with radio to determine the type of receiver best suited to their needs—and pocket books.

The log of the "Covered Wagon" will be of great value in checking the many important scientific, social, economic, and business problems in which radio plays or may be made to play an important part.

The American Radio Association

FOR several months, we have watched with interest and admiration the effort being made by the American Radio Association to pull the loose ends of radio together. They are making a valiant and praiseworthy effort to enable every listener-in everywhere to get the most out of his receiver.

This organization has picked out a number of ideals extremely difficult of attainment and has been on an up-hill trail from the first moments of its foundation. *But it has done things*—so many things in fact that it now has the hearty endorsement of many of the leading stars in the radio firmament.

Some day, perhaps, the story of Alfred M. Caddell, that able Secretary of the Association,

will be told. It will be the story of the successful attaining of an ideal which owes its existence to but one cause—the indefatigable effort to be of service to those vast numbers of radio folk who cannot be of service to themselves.

Veterans' Hospitals Should Have Radio Sets

NO WORK in which radio is a co-partner to-day so deserves commendation as the efforts to make it serve those disabled veterans of the War who are still confined to hospital beds. For most of us the War is becoming mere history, but for many it is yet, and will continue to be, a horrible vivid reality which is sapping their strength and holding them bedridden while the rest of us enjoy the pleasure of our country, preserved by their sacrifices. Could radio, itself practically a child of the War, be utilized in a more worthwhile work than in relieving as much as possible, the suffering and tedium of the long hours these boys have to bear?

Every normal American knows the answer to that question. Knowing it, why not do, each of us, our share to put radio in the hospitals where these boys pass their seemingly endless days? Why not help S. L. Rothafel in the wonderful work he is doing? If you haven't

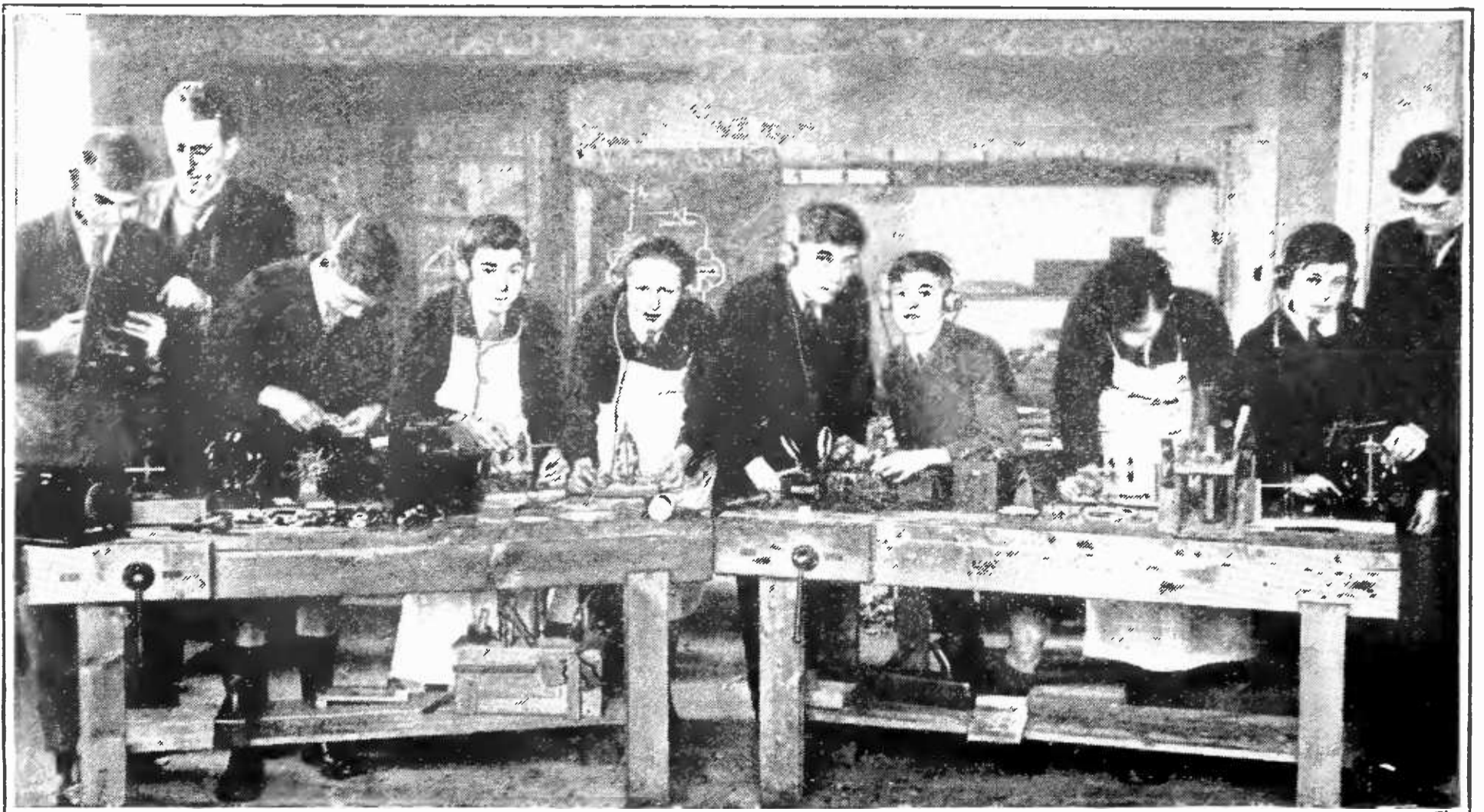

YOUNG ENGLISH RADIO CONSTRUCTORS
At work "building their own" at the Plymouth Junior Technical school

done so yet send in your contribution to his Hospital Fund so that those who need Roxie and his Gang more than you do, may have their burdens lightened and days made shorter and brighter as a slight reward for the sacrifices they made for the rest of us.

Radio Inspectors Ought Not to Be Censors

AN INTERESTING phase of radio broadcasting has been called to our attention by an editorial in the *Los Angeles Record* about certain water power rights. The California State Water and Power League is ardent that certain developments be carried out under a public ownership plan. They are opposed, naturally, by private power interests. The relative merits of the two schemes are much in debate, and probably will be so as long as there is water power to be developed. Knowing this no one is nowadays either irritated or deceived by the fallacious arguments put forth by those who take either side of this question.

The editorial in question denounces in unmistakable terms the broadcasting of a speech advocating private ownership, a speech in which it was no doubt conclusively shown that public ownership would involve the public in ruin and debt whereas private ownership would bestow upon the same public immeasurable benefits. Using a radio channel for the dispersion of such "misleading information" has thoroughly aroused those interested in public ownership, aroused them to such an extent that the radio inspector has apparently been convinced it was an immoral act, almost sufficiently to warrant the exercise of his censorship power. The Los Angeles attorney who spoke for the private interests is thus painted by his adversaries:

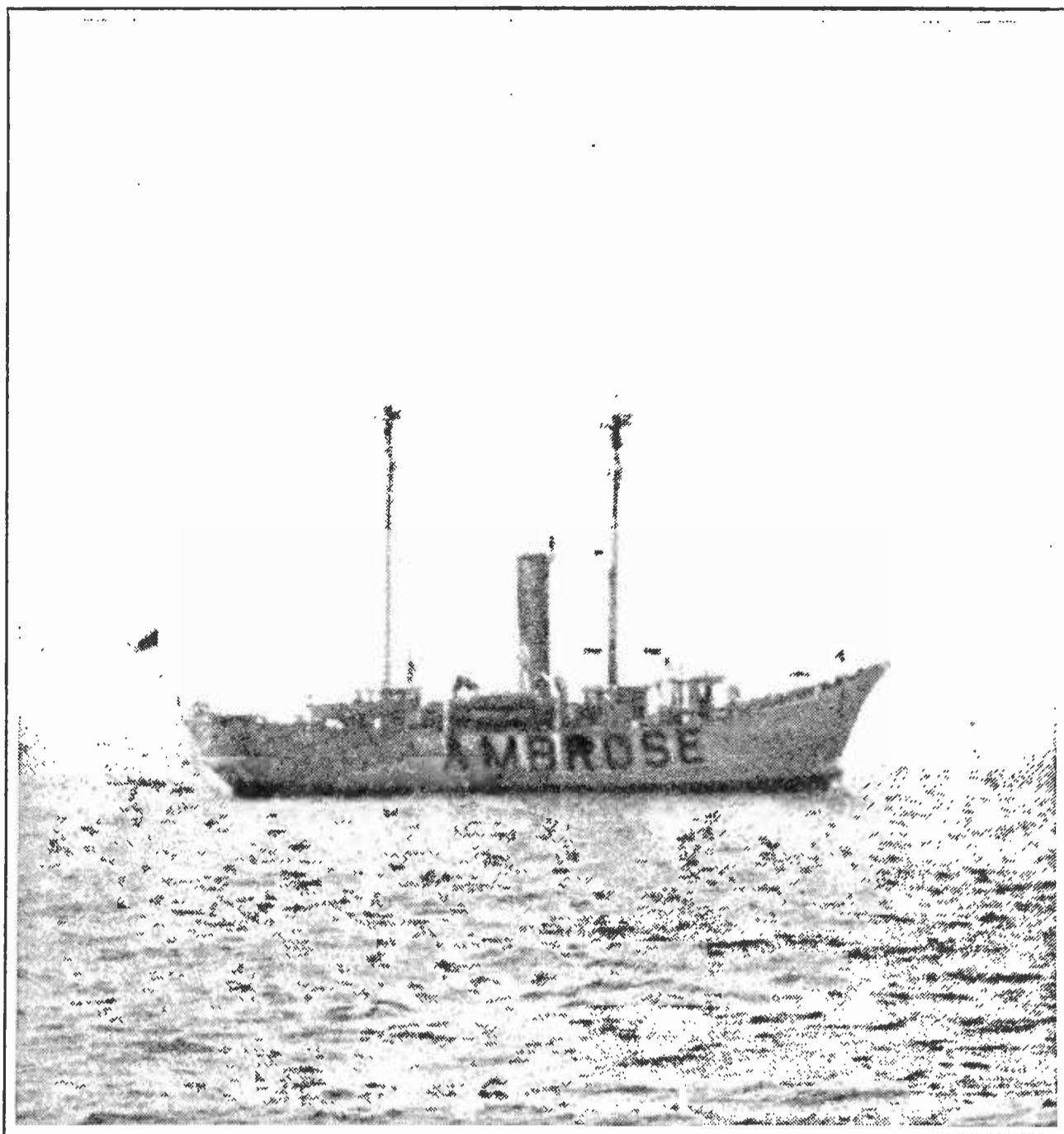

RADIO FOG SIGNALS

Are now being sent from Ambrose Channel light vessel. So radio supplements the present warnings to navigators which are in the form of light, and sound both submarine and atmospheric. The Light House Service is installing duplicates of this 250-watt continuous wave transmitter on various lightships at important places. The transmitter operates during thick weather and sends on a wavelength of 1000 meters

He went to San Francisco and polluted the air with a vicious attack on the Los Angeles municipal power bureau—your power bureau, that is successfully saving you from exploitation by private power profit seekers. He attacked the bond issue, which is about to go before the people. He attacked the Boulder Canyon project as a public ownership enterprise. He attacked the water and power act.

The Commonwealth Club, from which he broadcast is a notorious organization dedicated to service in the vineyards of the ruthless exploiters. It is a pool of economic and political stagnation from which arises a continuous fog of misleading propaganda.

We are asked to give our moral support to the local Federal inspector who threatens to withhold the privilege of the ether from men who present the private interests argument as did the Los Angeles attorney. Well—we doubt very much the power of the Federal inspector to stop the broadcasting of such matter—that

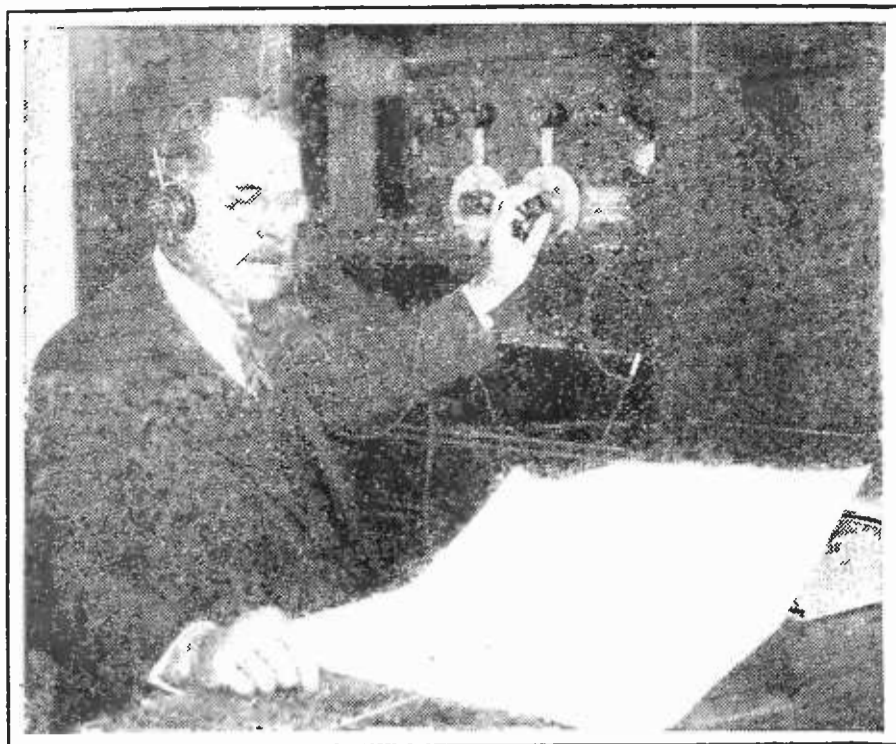

MAJOR EDWARD E. BOWIE

Chief United States Weather Bureau Forecaster. For many years, the Bureau has used radio telegraph agencies to broadcast their forecasts and condition of weather reports, many of which went from N A A signed "Bowie." Now the telephone broadcasting stations are used for the same excellent and helpful purpose

isn't in his province. We suppose the advocates of municipal control would be given the privilege of talking over the ether for presenting their case, and we hazard that their talks might be somewhat more vitriolic than was that of the private interests' representative. One side has as much right to be heard as has the other.

Europe and America Fascinated by the "Deadly Ray"

BY THE time this comes from the press we ought to know how deadly are these rays, by whose mere mention Grindell Matthews has kept the European press agog for nearly a month. He seems to have given the English cold chills by taking his ideas to France, to dispose of it to a French syndicate.

And so far he has shown just exactly nothing! By his mere word he has been able apparently to paralyze the reasoning powers of the editors, statesmen, and militarists. He must be a very smooth talker or else most of his interviewers have been near a nervous breakdown.

An interview with Professor Edouard Branly, inventor of the coherer (which the crystal rectifier displaced) shows the attitude of the true scientist. Never does he say it is impossible but——

As a scientist I must have proofs before I can

believe in this new invention. Such proof has not been given and consequently I cannot believe in the ray. As a scientist, if I consider the probability of the existence of the ray I must doubt the claims of the inventor. There is nothing in the present development of science to indicate the perfection of such a ray. Contrary to the popular belief, scientists do not expect such an invention.

To have a ray that will destroy, that will stop a motor, that will kill at a distance, one must have a ray with force in it. No such ray exists. Science has learned how to concentrate rays to a certain extent, but the rays have no great force in them.

Had the Britishers the infliction of Dr. Cook of polar and oil field fame, they would have been better able to cope with the deadly inventor; they would have required him to show them at least a little peep at his deadly weapon before having such a case of nerves as he has apparently been able to produce.

Licensing Broadcast Stations

IN A recent issue we had a few paragraphs under the caption "Outlaw stations to be closed"—it brought a very polite letter from the A. T. and T. Co., telling us we had not adequately presented their case and a rather more forceful letter from a reader who expresses the sentiment that if we "are paid to send out such propaganda for the telephone company, we should at least mark it so that the reader would know it was a paid advertisement." Well—Roosevelt used to say the only man who never made any mistakes was the man who never did anything, and we suppose he meant it to apply to his writing as well as to his political acts.

In the article in question it was stated that licensed stations were not allowed to broadcast for profit, one of the outlaw stations so claiming. It appears that this was in error, as the present form of licenses, some of which were sent to us, contain no such agreement.

The license fees are from \$500 to \$3,000 depending upon the size of the station. They are paid but once. The fee may be paid in installments if so desired by the licensee. The license forms seem reasonable enough and, at the risk of again being accused of being on the pay roll of the Telephone Company we venture to say that the fee is certainly no more than adequate to cover the various costly developments which the Telephone Company puts at the disposal of the licensee when he is operating one of their equipments.

Other Opinions of the "Squier Code"

SOME months ago we published an article on the Squier System of telegraphic codes and, according to one of our telegraph friends, the lay public was very likely to judge the telegraph companies too severely on the basis of the information there given. He sends us an analysis of the telegraph traffic managers' task showing where the Squier System might prove advantageous and other places where the present system is better.

The real merits of the case can only be appreciated by those having actual traffic knowledge and experience, but the summary of this traffic man's opinion on the question is as follows:

"The point I wish to make in this whole matter is not so much that no saving whatsoever could be had by the substitution of the Squier System but that from practical consideration such wholesale savings as were indicated in RADIO BROADCAST are doubtful of attainment and the saving, if any, would probably be negligible."

Calling Up Your British Relations

ACCORDING to the A. T. and T. officials it may be possible in the not distant future to sit in your own home and talk to a friend on the other side of the Atlantic. If the recommendations of the British Post Office to establish a suitably large radio telephone station are carried out, it will mean that telephone subscribers in our country may talk directly to English subscribers.

We have on this side of the Atlantic plenty of power to talk across with a reasonable degree of reliability in the winter months. For the summer we must still concede the superiority of static; either stations tens and hundreds of times greater than we have at present, or some sort of static eliminator (for which there seems no rea-

sonable hope) must be evolved before our summer time voices can be heard on the other side.

The British Post Office committee which has the matter in hand has just recommended that a 200 kw radio telephone station be erected in England using the same type of apparatus and control as has been worked out and found dependable here. Our radio engineers have been telephoning across the Atlantic for many months, but as there was no transmitting apparatus in England the conversation has been a one way channel only.

The great interference caused by atmospheric conditions is well illustrated by one statement from the engineers who have been doing the work. "The difficulties of the technical problems to be overcome are well indicated by the fact that atmospheric conditions often change so greatly that the amount of power required at one time to give audible speech in England may be 10,000 times as great as that required a few hours before." From this statement, undoubtedly conservative, may be inferred the difference between occasionally getting a message across and establishing commercial communication.

What Radio Can Do for Marriage

HOW it does tickle the vanity of some folk to read their names in the morning newspaper. Avery Hopwood and Miss Rosalie Rolanda plan to be married by radio,



ANOTHER NEW USE FOR RADIO

The Salvation Army in New York collecting funds for their recent Home Service appeal, aided by radio concerts. This photograph was taken in front of the New York Public Library

according to a press dispatch. He will be on board a ship returning from Europe and she will respond from one of New York's studios. In the actor's profession they tie and untie the marriage knot and with such facility and haste that the lack of seriousness at such a performance will not bother the principals at all. We have Radio Golf Balls, a Radio Cafeteria, Radio Pack for all sorts of ills, and many others of similar import so why not a Radio Wedding?

But it is so easy to get married that we think it a useless waste of the ether channel. Untying the marriage knot often proves more difficult than tying it, however, so we suggest that radio be put to work along these lines, where it might be of real assistance. Why not hide a microphone behind the curtain of the room where Percy's wife is to have a clandestine meeting with the man she should have married, Veronica's husband? Some one could watch for the arrival of the hero at the rendezvous, properly tip off the announcer, who would then send out to the world his well known refrain "The next voice you hear will be that of ——." The station manager who could pull off such an event would, we fear, be voted the "cat's whiskers" or some equally expressive term of approbation by the millions of BCLs who were tuned to his wave.

Subtraction and Legal Wrath Among the Big Five

MANY have remarked on the strange crew of bed-fellows in that offspring of the War, the Radio Corporation of America, and have often said that the natural tendency of such a group was to dissociate instead of to combine. According to testimony of the American Telegraph and Telephone officials, their company has already disposed of all its holdings in the Corporation, so that this member has already separated itself as far as possible from its war-time associates. Certain patent agreements, necessary as a result of the war-time pooling of developments in the interest of the Government, still bind it to a certain extent to the others of the group, but we are given to understand that no profits of the RCA increase the income of the A. T. and T. Co.

We heard recently of a suit brought to collect royalties for the use of a certain patent, being fought by a counter suit to force the patentee to pay back the royalties which had already been

paid! But the strangest one of all now comes to light; the Westinghouse Electric and Manufacturing Company in coöperation with Major Armstrong, has started suit against the A. T. and T. Co., the De Forest Radio Telephone and Telegraph Company, the General Electric Company, and certain individuals, among whom is the Secretary of the Navy.

The patent involved is one for "an improvement in method and apparatus for producing sustained electrical oscillations" so evidently is one which may be seriously affected by the recent decision of the oscillating triode in favor of De Forest. If so, more suits loom up in the foreground, for all of which the public pays.

The Radio Drama Needs a New Technique

WE HAVE heard a great deal about the violence done to the sales of popular songs when they are sent out over the radio channels—without a suitable royalty. Now we have the same reaction in the case of plays sent out from the broadcasting studio. And as we read the opinion of Mr. Edward Childs Carpenter, the president of the American Dramatists, we are inclined to believe as he does, an effect the loquacious attorney for the American Society of Composers, Authors and Publishers was quite unable to produce.

Says Mr. Carpenter—"Radio is after all, but hearing the words of a play. A play is written to be performed. Without actors any play is bound to lose its effectiveness. The appeal of any play is in the action and the staging, and no play has really been properly presented nor has the integrity of the author's idea been presented without the complete presentation in a theater, with production, costumes, scenery, music, lights, and the other elements that go to cast the atmospheric spell intended by the playwright. . . . It is not at all impossible that radio will evolve a technique all of its own in the matter of dramatic production."

The Light Socket Receiver

THE receiver which requires no batteries is sure to come, and it is sure to come because there is a tremendous demand for it and because it's possible and because it is sound engineering. What BCL prefers to continue the practice of buying new dry batteries (when he isn't testing them to see if they are any good) instead of connecting the set to an ordinary light socket and using only a switch to start and stop the set?

It seems strange that some one hasn't done it before, but even now, we hail as an advance the set which functions without either A or B batteries. It's comparatively simple to use storage batteries for the filament and plate circuits, mount them in a box fitted with a rectifier in such a manner that whenever the set is being used the batteries are put on charge, thus doing away with the necessity of periodical charging, but this isn't what we have in mind when we speak of a light socket set. A light socket set pure and simple, without any batteries at all—that's the idea. Of course we can't expect that kind of a development to be pushed very hard by the dry cell manufacturers because it will seriously damage their very large business. The inventor of such a set should find it easy enough however to float his scheme (if it is good) because there is certainly a mint of money to be made out of such a device. The device needn't be very high in first cost and its maintenance will be practically nothing. There is already one such set on the market, and we know of another that looks like a winner.

It is comparatively easy and cheap to build

an outfit for drawing the plate current from the alternating current mains, but for the filaments, the required investment is quite a bit more. The Radio Corporation apparently controls an idea on a triode explained nearly ten years ago which uses alternating current for the filament. This tube gives much greater amplification than the ordinary kind and functions much better as a detector, yet for some reason not at all clear it is not put into production. Probably it will be developed rapidly enough when the patents on the triode as at present constructed expire, and the Corporation has to meet competition in the triode market.

When this idea was mentioned in these columns before, it called forth a peculiar response from one of those participating in the development policies of the RCA, the main argument of which seemed to be that the general public was well satisfied with the dry cell tube! Of course the public hailed the dry cell tube with delight when they compared it with the older storage battery type, but that doesn't mean they would not prefer to use no batteries at all.



TAKING THE BATTERIES OUT OF THE RADIO SET

Harry W. Houck (left) is holding his invention which is said to do away with A and B batteries. It is a plug which fits into any alternating current light socket. William Dubilier, radio manufacturer, is pointing out to the audience of radio editors the first model of the device. Raymond Francis Yates, of the New York *Herald-Tribune* is standing between Mr. Houck and Mr. Dubilier. Orrin E. Dunlap, Jr., of the New York *Times* is on the extreme right

The dry cell outfit would still meet with much demand for quite some time even though the light socket set were put out at a reasonably low price because there are still localities where power is not available. But for the average city and suburban dweller the light socket set



GENERAL PLUTARCO CALLES

One of the prominent candidates for the Mexican Presidency at the July elections, making an address before the microphone of a Mexico City broadcasting station. In the Mexican system, four microphones are connected in parallel

is sure to come, because it is possible, economical, and people want it.

Are There No More Miracles?

IN ONE of our earliest issues it was pointed out how quickly the American people accustom themselves to new things, with what nonchalance they view a wonderful machine which was perfected only the week before.

A radio novice was permitting his friend, a clergyman, to listen-in with his set and the wife of the clergyman was broadcasting from a distant station. With the same eagerness to show his friend some of the novelties of radio that all of us exhibit when we find some one who knows less about radio than we do, the clergyman (who probably wanted the enthusiast to leave the set alone so he could listen) was made to see the effects of mistuning, interference, and all the other tricks of the receiving set. He found that even though the antenna was disconnected, the currents from the ether were still able to convey to the listener the words of the distant speaker. Seeing that the radio currents which were actuating the receiver must be coming through his body (he had the antenna in one hand and the antenna binding post in the other) he could not repress the statement, "And yet some people say there are no longer any miracles!" "Just body induction," was the matter-of-fact rejoinder of his friend.

Well, we side with the clergyman. A miracle is something we cannot understand, and in spite of the fact that the phenomenon of induction has been known many years it is today as much a miracle as it was to Faraday or the other early workers in this field. We are surrounded by miracles and he who is so devoid of imagination (or so self-satisfied with his supposed wisdom) as not to perceive them operating around him every day is missing much of the interest and stimulus of this age.

Great Minds Still Disagree on Broadcasting Payment

WHO pays? continues to call for much comment and inquiry from the press. The *New York Times* printed interviews recently with many of those most vitally interested in radio, from which the still greatly diversified views on this question may be gleaned.

Herbert Hoover believes that broadcasting will be supported as it is at present and that the stations will be organized into six or seven great national circuits for using economically the finest talent in simultaneous broadcasting.

H. B. Thayer, President of the American Telephone and Telegraph Co., while offering no definite suggestions, did say that he doubted very much the probability of using specially modulated waves, for which specially built sets, to be obtained from the broadcasting company only, would be required. Such scrambled messages are possible, he said, but at the same time he doubted their efficacy in making broadcasting self supporting.

David Sarnoff of the Radio Corporation grasps the idea we put into our very first issue—that the broadcasting station will be endowed as are other great public institutions. Philanthropists have still to be attracted by the possibilities of this scheme, but times and people change and we may expect much. Radio already contributes much to the happiness of mankind, and when this is more appreciated radio will appeal to the givers of gifts as have done libraries and other public institutions.

For the General Electric Company, Martin P. Rice expresses the opinion that the BCL should contribute to the support of broadcasting, either by voluntary contributions, or by the licensing of sets or similar scheme.

Heywood Broun, in one of his typical tirades,

doesn't know who is going to pay the broadcasting artist, but he is perfectly sure someone is going to pay if he has anything to say about it. He says:

Until radio came along this sort of graft was beginning to diminish. Communities were beginning to realize that it was sheer nerve to ask anybody to speak, or read his poems, or tell a few funny stories without offering a fee, however small, in return. Then radio burst into the world and gall returned in a most noxious form. The broadcasters do not pay. Instead they offer the performer publicity. It is a highly depreciated currency. People who ought to know better yield to the lure.

As for the thousands of letters one is supposed to receive Broun is of the opinion that the artist can neither feed nor clothe himself with them and further that "it must be a fearful nuisance to read them all."

E. C. Mills, for the Society of Composers, Authors, and Publishers, with his usual shrewdness, develops an ambitious plan of forcing the public to pay well for the performances of artists.

China to Have Broadcast Service

REGULAR radio broadcasting has been started in China; *Shu Pao* gets the credit for being the first newspaper in China to put itself in line with its American contemporaries. Four times a day music and educational lectures in Chinese are broadcast.

The Oscillating Tube in a Legal Tangle

MOST radio fans at once associate the regenerative circuit, and the oscillating triode, with the name of Armstrong, but according to Dr. De Forest's attorneys, this should not be. In their words—"by some preliminary litigation and wide publicity given the controversy between Dr. De Forest and Armstrong, the public has been led to believe that Armstrong was the inventor of the so-called feed-back and regenerative circuits. On the other hand De Forest continued his fight and after seven years of continuous litigation has now, by the court of last resort, been given credit to which he is so justly entitled."

The occasion for the announcement of De Forest's attorneys was the recent handing down of a decision in the United States Court of Appeals for the District of Columbia. Con-

trary to the opinion of the patent office examiners the Court has ruled that De Forest was the inventor of the oscillating triode. This had nothing directly to do with the regenerative patent, which has been adjudicated in Armstrong's favor, but relates to the production of oscillations only. Armstrong entered two patents—one to cover regeneration and one specifically on the production of oscillations. It is the latter which has been decided in De Forest's favor.

Continuing, De Forest's lawyers say "it is impossible to foretell how far reaching the effect of this opinion is going to be. It is certain that the Radio Corporation of America, which is licensed under the Armstrong rights, and the Westinghouse Company, one of the members of the Radio Corporation, have received a set-back which may have very disastrous results."

It seems that even this decision does not entitle De Forest to sit back and begin to collect royalties, as more litigation still faces him before his alleged priority in this field of invention is finally decided. How many more Courts there are still to be convinced we do not know, but we do know that Armstrong and the Radio Corporation are at present busy collecting data to show the next court they encounter, that De Forest's contentions in the

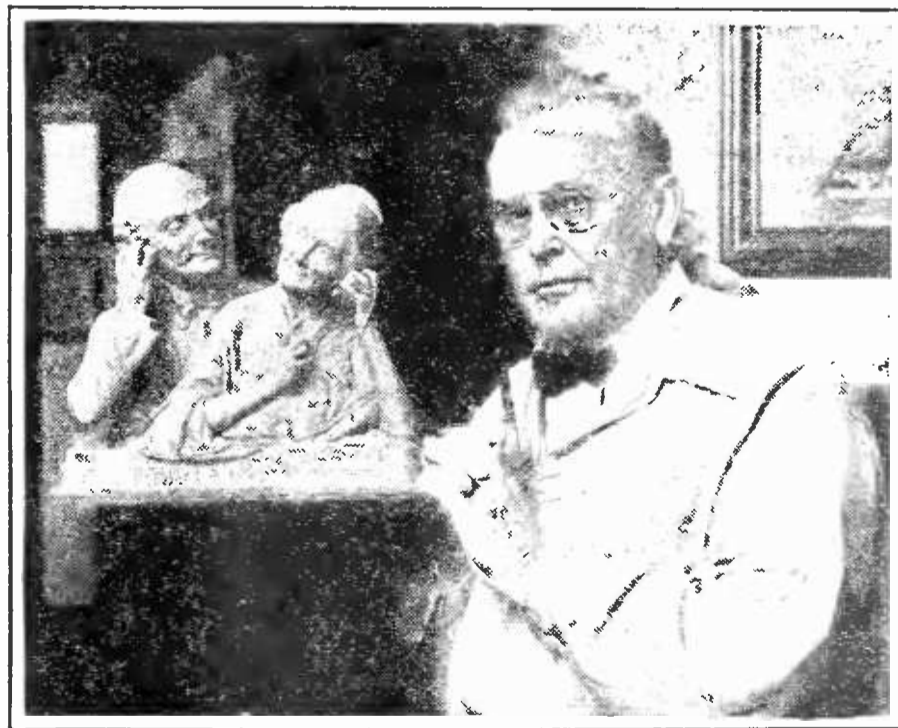

THE RADIO MOOD—IN CLAY

W. Clark Noble, a sculptor of Washington, D. C., standing beside his recently completed work, "Listening-In"

lower court were not sustained by reputable witnesses. Certainly the patent lawyers have reaped a rich harvest from the triode, whatever the real contributors to its development may get.

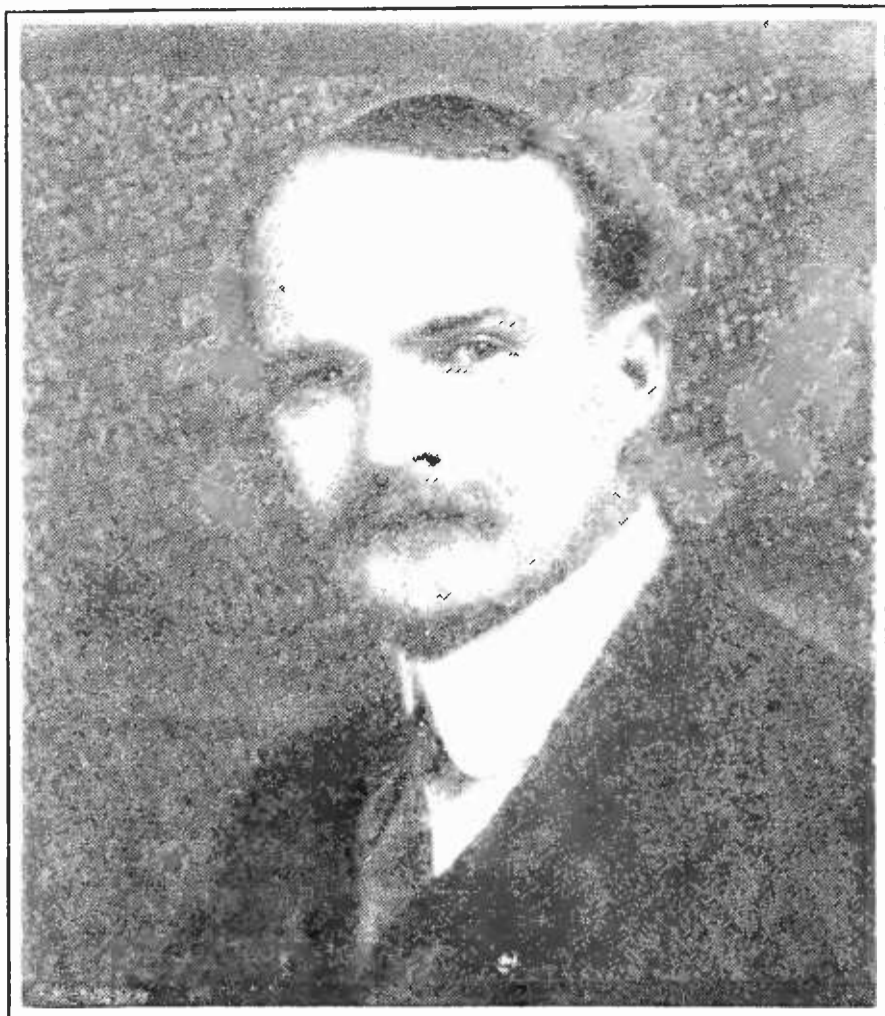

E. S. MARTIN

Secretary, Editorial Board, Boy Scouts of America

"Ninety-Seven per cent. of the six hundred thousand members of the Boy Scouts of America are interested in radio, which was proved by a questionnaire we recently sent out. This fact is significant to those who are studying the potentiality of the various interests of youth, for radio, more than any other interest, keeps the boy at home. I hail the advent of radio as offering to the youth of America an interest which is at once a challenge to their intelligence, ingenuity, and skill, and a constant source of entertainment of value"

W G Y Too Busy to Test

RADIO is growing so rapidly that those vitally interested must continually strive to keep up with the new things discovered by others and also discover some for themselves. Many of the laws of radiation are still not clear and much experimenting has still to be carried out to ascertain the relative merits of short and long wave transmission. Many other important problems are in the same unsettled state.

If you listen at perhaps three o'clock in the morning you may hear tests of all kinds going on from well known stations. For experiments must be carried on in the off hours when the BCL is in bed or at work. Even with this apportioning of time W G Y is not able to satisfy its needs. The General Electric Company has decided to put up another station, and keep it busy entirely on experimental work. It is expected that \$150,000 will be

required to erect the station and that it will be put up this summer at some point well away from the main General Electric plant where W G Y is located. Tentative plans call for a very flexible equipment, capable of sending large power at short wavelengths. The station will probably be very popular with the radio research men of Schenectady as there is a tremendous amount of important and fascinating work waiting to be attacked by just such a station.

New Radio Books are Few

OF LATE there has been but little or no activity in the radio field by the book publishers. Apparently the radio book market is saturated. We know stacks of various elementary radio books for which the anticipated demand did not materialize so that they are in dead storage and must be ultimately consigned as waste.

In writing a radio book the author generally tries to explain the underlying principles of radio or to show how to build and make certain sets function. The first idea yields a book that requires study; not mere reading, but real work, for it is not to be expected that a knowledge of scientific principles can be obtained any easier out of school than in it, and surely the students in school find it no easy task to master radio principles. The advantage of so mastering a book on principles is obvious however—anything gained from it is of permanent value and can be applied to any radio problem. On the other hand to read such a book is not as easy, nor to many as interesting, as reading one on how to build a set.

The trouble with the "build your own" type of book is that the information given rapidly becomes out of date, because of the changing art. New types of coils and circuits (the principles of which are the same as before but the arrangement and construction of which are different) are continually coming to the front, so rapidly that it is hardly worth while to invest in such a book. The better type of radio magazine is taking care of this field so well that more books on the subject will probably be failures from the sales standpoint. It is better to get a good book on principles (too hard for mastery at the first reading) and then keep abreast of the advance in constructional developments by reading the better class of radio periodical.

A Powerful New English Station

THE *Daily Mail* tells us that Great Britain is to have the largest and most powerful radio station in the world designed for direct communication with India and Australia.

The work of clearing over a square mile of country where the station is to be located has already begun. Sixteen masts, each 820 feet high, will be distributed over this territory to support the vast span of wires which will form the upper part of the antenna. When we picture this network suspended in the sky we can well sympathize with the small boy who had been taken to see one of the large transatlantic stations, and who queried of his all-knowing parent, "Why do they call it wireless, dad?"

Interesting Things Interesting People Say

COLONEL J. F. DILLON (San Francisco; Department of Commerce: Radio Supervisor for the Pacific Coast radio district): "There are more than 500,000 receiving sets in homes, offices, and business houses in California. At least three persons listen-in at each of these receivers, which makes a total of at least a million and a half radio listeners in the state. Four million radio listeners on the Pacific Coast would be a conservative figure."

C. J. WEST (Columbus, Ohio; State Federal Crop Statistician): "One farm in every seventeen in Ohio is equipped with radio. This means that approximately six per cent. or 7,500 rural homes in the state are equipped with radio receivers."

HOXIE NEALE FAIRCHILD (New York City; Director, Home Study Department, Columbia University), speaking of the radio course in Browning which he recently broadcast from WEA, New York: ". . . People who formerly had turned their noses up at radio promptly turned them down again when they heard of that course. . . . But this experiment proved that a good proportion of the radio audience was willing to listen to literary discussions. Now students are turning radio fans and radio fans are turning students."

"Radio as a mechanical marvel is growing stale. People are beginning to ask: 'Now we have it, what are we going to do with it?' Education is the one great answer to that question, and long distance education means books.

"Here's another suggestion. At present some book stores have lectures, but this fine plan is not

practicable for all. But there is hardly a book shop in the country that could not install a radio set and invite people to listen to these courses. And naturally you would have on hand books connected with the topic of the lecture."

S. HUOK (New York City; concert impresario, and manager of Pavlowa): "To-day, radio entertains thousands of people who never have been reached by concerts or the gramophone. People who own radio sets look up the programs to see what is being broadcast. They read that the aria from 'La Bohème' will be sung that night from a certain station. They become interested and ask questions. 'What is 'La Bohème'?' They look it up and learn that it is an opera. They want to read the libretto. They become interested in the soloists and inquire about them. In this way, an interest in music is created which is beneficial to concerts, because all these listeners are prospective attendants.

"Of course, radio is not yet perfect, but the experiments now being performed will remedy the minor defects which exist to-day. Some of the transmission is poor, and I believe that the piano goes over the ether with less fidelity than any other musical instrument. Vocal selections are in most cases the best. . . . In the long run, I feel that music will benefit directly from radio."

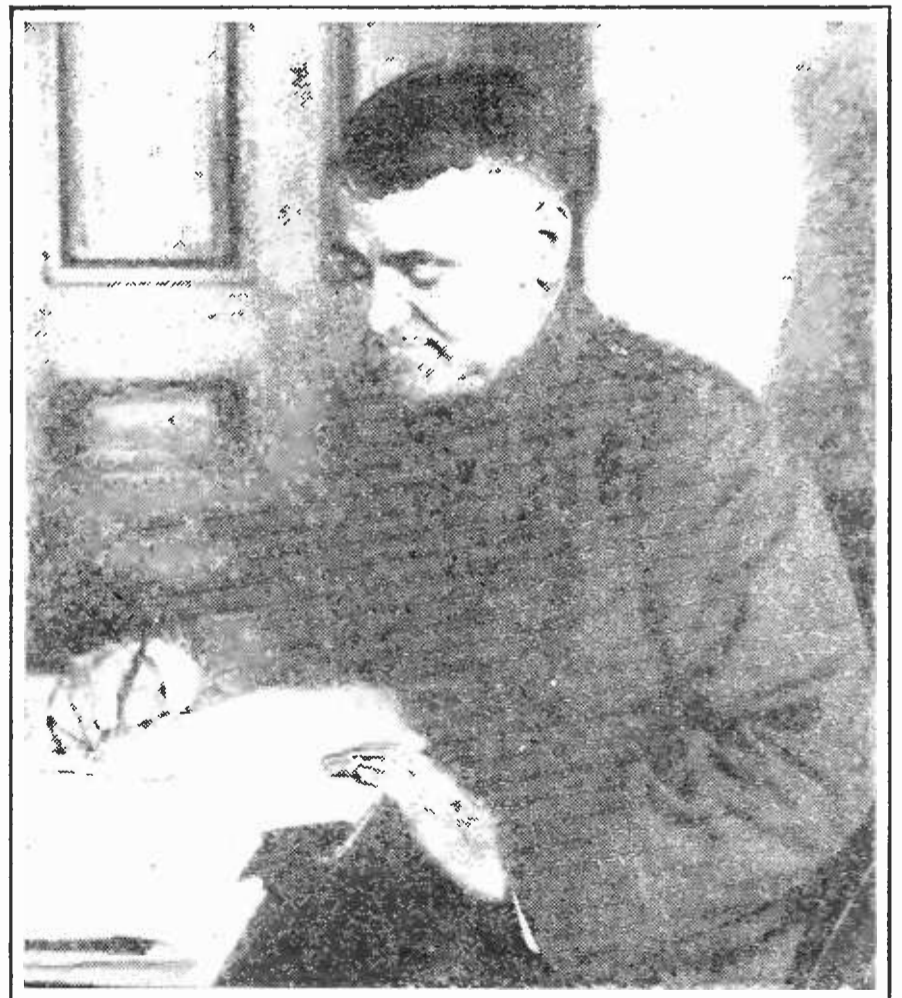

© Underwood & Underwood

JOHN T. AXTON

Chief of Chaplains, United States Army

"The degree of cheer and comfort which radio is giving to the disabled veterans in our hospitals, can hardly be realized by those who are well and whole"

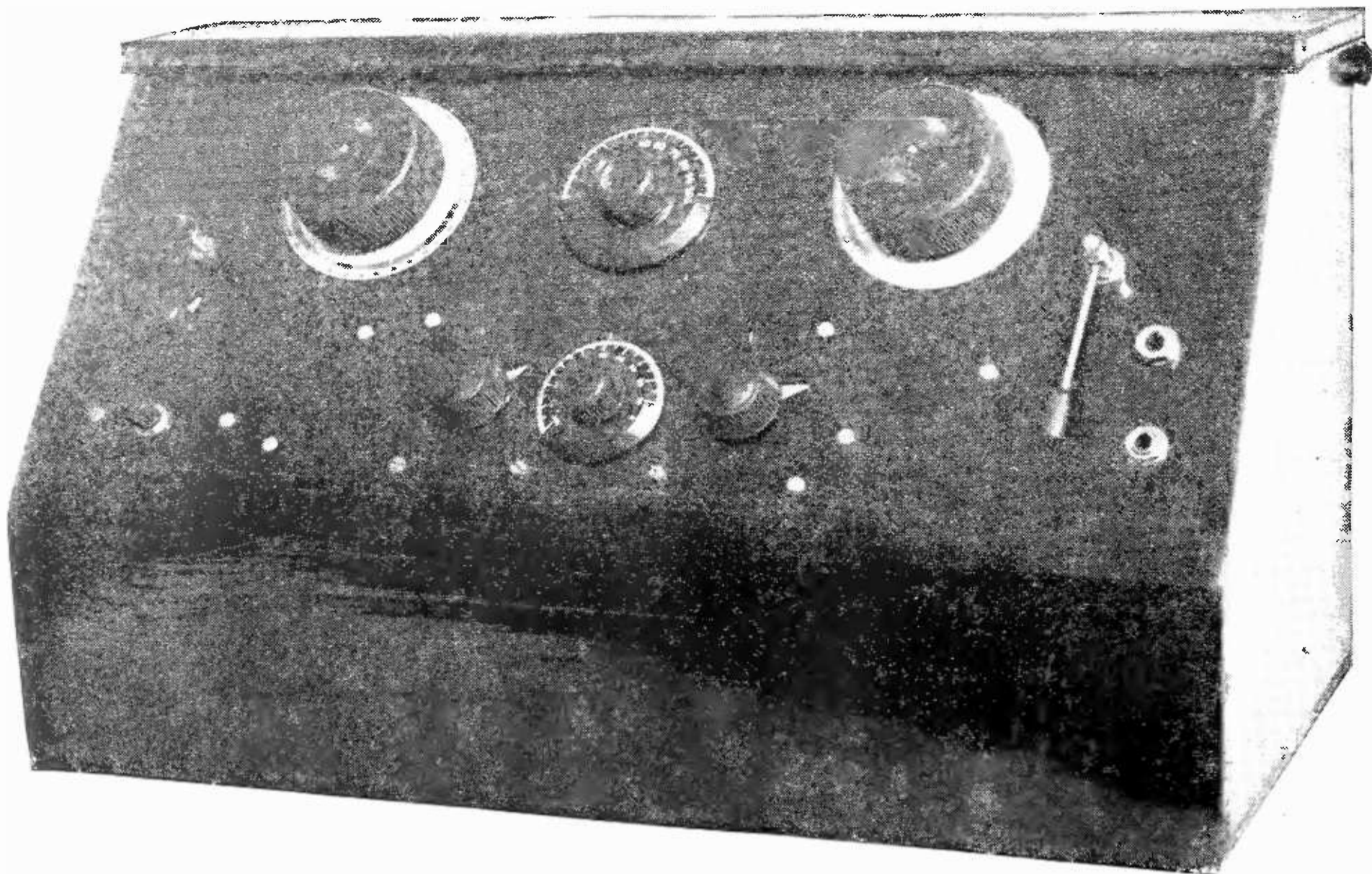

THE ROBERTS THREE-TUBE KNOCK-OUT RECEIVER
Designed and incorporated in a cabinet of his own design by Mr.
J. E. Roberts, of Cleveland, Ohio. The set cost exactly \$51.90 to build

Building a Knock-Out Three-Tube Roberts Set

Suggesting Improvements in Design of the Roberts Two-Tube Knock-Out Receiver—A Selective, Sensitive, Dependable, Non-Radiating Set—The Parts Cost \$50 and are Standard

BY J. E. ROBERTS

THE article appearing in the April issue of RADIO BROADCAST, entitled "A Knock-out Two-tube Set" was of particular interest, in that it apparently described an ideal receiving set of its class which offered specifically three outstanding advantages—

Economy and performance of a two-tube reflex, with a tube for detector, instead of a crystal.

Selectivity and DX range of a regenerative set with two stages of amplification, without the vice of radiation.

Ease of control, stability, and other virtues of a neutrodyne, without the complication or multiplicity of tubes.

Any of these advantages alone is well worth trying for, so the result was that a set was hooked up, temporarily, on a base consisting of the end of a soap box, with a "false" panel, of wood, to carry the condensers—exactly in accordance in every detail, with the description and diagrams in the April issue, and the product though rather short on good looks, produced results much in excess of those promised, either specifically or by inference.

It was apparent that this hook-up was much too efficient to be allowed to remain in temporary shape, and as it seemed possible to put it on a panel in a compact and workmanlike manner, with a possible further improvement

due to perfect connections, proper spacing of instruments, etc., the set was rebuilt on a 7" x 18" panel, and laid out to fit a cabinet, 7" x 18" x 8" inside dimensions, and this hook-up was completed some weeks in advance of the panel layout shown in the May issue of RADIO BROADCAST.

In this second hook-up several changes were made which promised more efficient or simpler operation, and while some of them did not show material advantages, the rest of them were apparently improvements and were incorporated in the set as it now stands.

THE CHANGES MADE IN THE ORIGINAL DESIGN

FIRST, the A or primary coil was found to have a very satisfactory effect if it were arranged so that the coupling with its partner (Coil S-1) could be easily varied—in other words, if a variable coupler was made of these two coils—and this was done, by mounting Coil S-1 directly on its variable condenser, and then varying the coupling by mounting Coil A on a bracket which would allow it to rotate through an arc of about 20 degrees in the same plane as Coil S-1. Details of this mounting are shown in Fig. 3. The results obtained were particularly noticeable when it was desired to make a selection between two stations operating at the same time on a wavelength nearly the same—with a difference of 10 to 20 meters, for example.

Second, the neutralizing condenser C was replaced (as suggested) by a two-plate variable condenser—this was mounted on the panel, and while there is no necessity for frequent variation of this capacity, yet it often aids in im-

proving reception—furnishing just the little variation that is necessary to make it “just right.” The grid wire, spaghetti, and brass tube combination are efficient, but they are inconvenient to reach and adjust, particularly if the set is enclosed in a cabinet.

Third, the fixed grid leak shown on the detector tube was replaced by a Cutler-Hammer variable leak, and the control brought through to the panel—a fixed grid leak was not satisfactory, owing to the difficulty of getting just the right resistance—and while the variable leak needed no attention after the right adjustment was found, it was certainly possible to get just the proper resistance more easily and to change it in the case of a change of tube in the detector socket.

Fourth, Coils N and P, and S-2 were mounted directly on the back of the condenser controlling that circuit, coils N and P being $\frac{1}{2}$ " from the back condenser plate, coil S-2 on the same center post, $\frac{3}{4}$ " from N and P, and centered with them. Coil T was then centered $\frac{1}{4}$ " from S-2 and arranged to rotate through an arc of about 30 degrees in the same plane, and the control carried out through the panel for convenient adjustment—as in Fig. 2.

Fifth, a Frost single-circuit switch was hooked in the common wire carrying the — B and + A current as a matter of convenience and possible economy in battery current.

In addition to these direct changes from the original specifications, several little details were noted that were of advantage. As will be noted from the photographs, Univernier dials are used in connection with the two tuning condensers, the condensers themselves having no vernier plates. This type of dial is an ab-

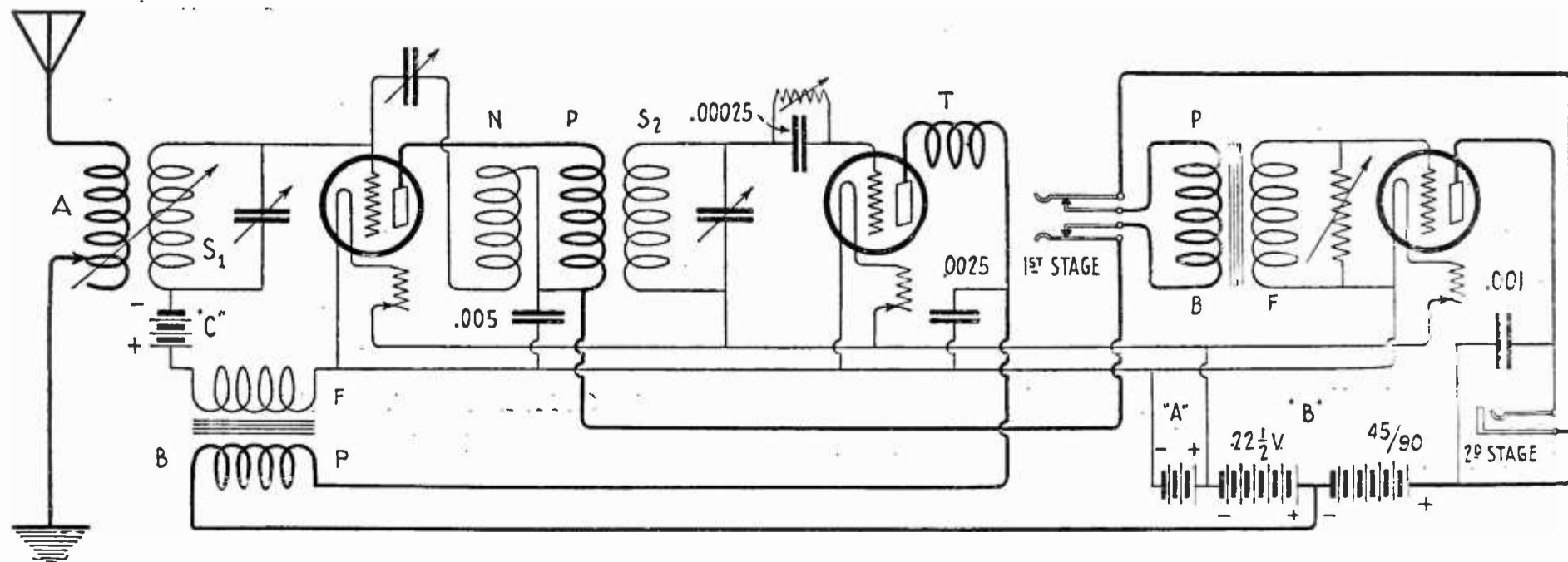

CIRCUIT DIAGRAM OF THE ROBERTS TWO-TUBE RECEIVER

With an additional stage of audio-frequency added. Note the variable grid leaks in the grid return of the detector tube and across the secondary of the second audio transformer

solute necessity on the second condenser, since even with the reduction of 12 to 1 obtained by this dial, the difference between good and poor reception is a matter of a very few degrees—with an ordinary dial, this condenser would be most critical, but with the vernier dial it is not critical—merely *accurate*.

The dial in the primary circuit tuning coil S-1 need not be a vernier, as the adjustment in this circuit is much less fine, but the advantage of having two dials alike is found in logging stations. In the set in question, these two dials run approximately together, making the simplest sort of tuning—for if a station is brought in on 80 on the first dial, the best reception will be found by locating the second dial between 78 and 82. W B Z comes in on 60-60, W W J on 155-156, W O O on 138-140, W H A M on 41-45—and it can also be noted that there is a direct relation between dial settings and wavelength, so that a dial can be set approximately for any station not logged, if the wavelength is known, and the variation of a few degrees either way, will bring that station in—if it's on the air.

Tickler coil T—specifications called for 20 turns. Later, this was changed to 18; in the set described, both 20 and 18 turns were tried and later reduced to 15 turns—which, *in this set*, gives the best results.

CONSTRUCTION EXPERIENCES WITH THE SET

IN WINDING these spider-web coils, whether on home-made or purchased forms, it has been found that better results were obtained, and much less trouble, by using the proper gauge of *enameled* wire, rather than silk or cotton-covered. These spider-web forms are liable to have a sharp edge, and in threading the wire down into place, this edge cuts through the insulation of silk or cotton, resulting in two or more turns being shorted. The enamel is

much tougher, does not scrape off or “open up” on sharp turns—and in addition takes less space, and looks better, and *doesn't absorb moisture*.

Tubes were mounted on brackets made of $\frac{1}{4}$ ”, No. 18 “half hard” brass, and long enough to allow a little spring—this prevents microphonic noises from the tubes, and also insures safety for the tubes when the set is moved—this particular set being intended to be a portable set.

It has been compared in operation to a number of other sets and has been operated in several instances with the same conditions of antenna, ground, location etc., and in every case has shown its value. This two-tube set, consisting of 1 stage of RF, detector, and 1 stage of AF (reflexed) was fully the equal of a two-tube reflex set in volume, clarity and distance—the reflex consisting of 1 stage of RF, crystal detector, 1 stage AF (reflexed) and one stage of straight AF.

In this case, this set operated on the same tubes, batteries, antenna, ground, and loudspeaker as the reflex and in the same location.

It was then decided to experiment with the addition of another stage of audio frequency to this set—

making it a three-tube set, and incorporating one stage of RF, one detector, one stage of reflexed AF and one stage of straight AF. Fig. 1 illustrates the hook-up, and the photographs show the general construction details and layout, as well as general appearance of the completed set, in and out of its cabinet.

THE SET COMPLETE WEIGHS TWENTY-TWO POUNDS

THE entire set is mounted on a 7" x 18" rubber panel, and included in a cabinet, 19" long, 10" deep and 11" high, which cabinet also includes three dry cells in parallel, for the A battery, a 3-cell C battery block, and

The Roberts Set—Dressed Up

If there has been one receiver which has called forth general approbation and enthusiasm from our readers it was the Knock-Out One-Tube Set. But soon after that had jumped into such general popularity, along came Mr. Walter Van B. Roberts with his two-tube receiver which has all the advantages, and more, that one could ask from a set using two tubes. The great number of enthusiastic readers who built up the Roberts Set, which was described in this magazine for April and May, lost precious little time in writing us the excellent results they got from the outfit. All of them praised its sensitiveness and selectivity. And among these enthusiasts was Mr. J. E. Roberts, of Cleveland, who put the set together, plus another stage of audio according to his own ideas—which, by the way, are excellent ones.—THE EDITOR

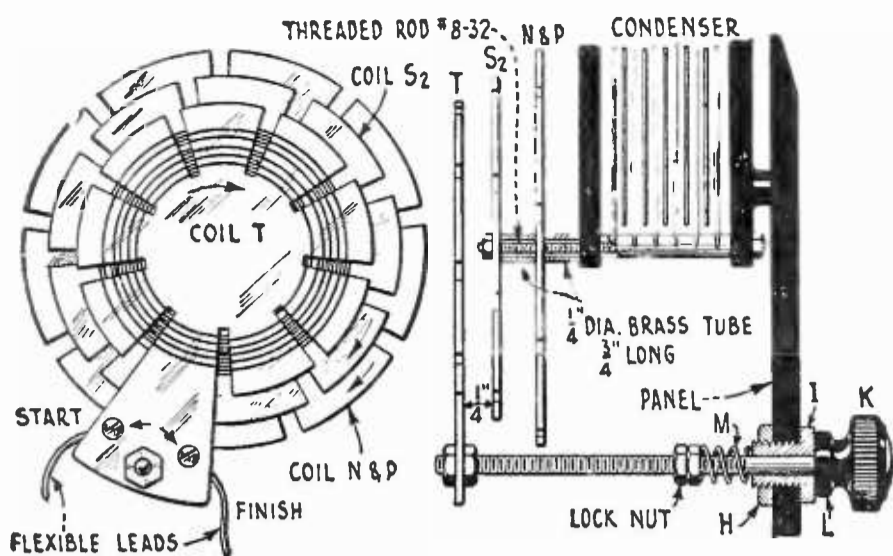

DETAILS OF THE COIL MOUNTING

Of coils N and P, S-2, and T. H, I, K, L, and M, are nut bushing, knob, lock-nut and spring of standard switch assembly. J is $\frac{5}{8}$ " threaded brass rod, whose length varies with the distance of the coil S-2 from the panel. A lever 3" long can be used in place of knob K

two blocks ($22\frac{1}{2}$ v. each) of B battery, with room enough for two more blocks—making 90 volts. The completed set, with everything ready for the pushing of the battery switch, weighs about 22 pounds, and is very distinctly portable, being no larger or heavier than the well known Gladstone bag—and not so heavy as many of those bags, when filled.

The three-tube set is nothing more nor less than the two-tube set as originally built, right up to the output jack. A two-circuit jack was substituted for the single circuit jack on the original set, and the second stage of amplification, which is the regular second stage standard hook-up in every way but one, was connected in the standard way to the terminals of the two-circuit jack, as shown in Fig. 1. The only exception to the regulation AF hook-up is the inclusion of a *grid-leak*, across the *secondary* terminals of the *second* transformer. Almost as good a result can be obtained by shunting a .002 mfd. fixed condenser across these terminals, but a variable grid leak is to be preferred.

The location of a grid leak in this position is of very great advantage in preventing distortion, particularly on strong signals.

WHAT THE SET WILL DO

THE resulting set is most satisfactory in every way—it is compact, and easily handled and portable in the strictest sense—it uses three tubes, and gives the equivalent of four and five in volume—it is easily tuned, and a station once logged, can be returned to again and again, quickly and easily—it is stable; once tuned-in it can be forgotten till the end of the program—it is selective, as it will bring in

out-of-town stations through powerful locals, even when the wavelengths differ less than 20 meters. Two tubes are all that is necessary for loudspeaker results from stations up to several hundred miles, consistently, further, on occasions; three tubes will bring in anything up to 1500 miles on the horn and many of the smaller powered stations in the same radius on the phones.

Following is a copy of the log-book of this set for three days (or nights):

May 1st	WGY	380 m	Primary	4	Cond's	81-87
	WBZ	475	"	4	"	60-60
	KYW	536	"	5	"	170-168
	WOO	509	"	5	"	138-140
	WIP	509	"	5	"	138-140
	WHN	360	"	3	"	62-62
May 2nd	8AJ	Amateur	"	4	"	21-13
	8BOP	"	"	4	"	21-13
	WDAP	390	"	4	"	70-67
	WHAS	400	"	4	"	86-85
	WSB	429	"	4	"	110-108
	WDAF	411	"	4	"	95-91
	WOS	441	"	4	"	110-114
	WGN	370	"	4	"	75-73
	WDAR	395	"	4	"	86-81
	WJZ	455	"	5	"	114-119
	WGR	319	"	4	"	52-50
	WLAG	417	"	4	"	100-98
	WLS	345	"	4	"	65-61
	WOQ	360	"	4	"	65-65
	WHB	411	"	4	"	93-93
May 3rd	WHAM	283	"	4	"	45-41
	WWJ	517	"	4	"	155-156
	KFKX	341	"	4	"	61-61
	WCX	517	"	4	"	155-156
	WSAI	309	"	4	"	48-45
	WCAE	462	"	5	"	120-120

In all cases noted, this reception was ample for the phones on two tubes—in about half the cases, it was sufficient for loud speaker reception. On three tubes, they were all amply loud for comfortable reception with but one exception (WLAG) which was poor on this occasion. In all cases excepting WGY, WDAP WGN and WOQ, reception was through local broadcasting.

PARTS REQUIRED

FOLLOWING is a list of parts used in the three-tube set illustrated, at local prices. This list shows that the three-tube set can be built out of reasonably good material complete for less than \$50.00, exclusive only of the cabinet and phones (or loud speaker units).

It is to be noted that this entire description refers to several sets. One of them was temporary, another, a complete two-tube set on a panel and a complete three-tube set, on a panel and in a cabinet, which were operated with the results as outlined, on two, and later, three

WD-12 tubes. Trial was made on the two-tube set, of a pair of boot-leg tubes of the 201-A type with results less satisfactory than those produced by the WD-12's. The two-tube set was also tried with two 201-A Radiotrons, with a 6-volt storage battery on the filament, and 90 volts on the plate of the first tube. The results were but very little better than the results produced by the WD-12's.

PARTS REQUIRED

2	23 plate RVC variable condensers	\$ 4.00
2	Univernier Dials	2.50
3	Fada sockets	2.25
3	Rheostats	1.50
5	Spiderweb coil forms50
	Wire (enameled) for coils50
1	Cutler-Hammer grid leak	1.50
1	Double circuit jack75
1	Single circuit jack50
1	Jefferson Transformer 6:1	3.50
1	Jefferson Transformer 3:1	2.50
1	Frost Battery switch25
1	Inductance switch for primary taps75
2	Switch levers (for coupling control)75
1	2 plate condenser variable	1.00
1	Dial for same25
3	Micadons (.00025, .0025, .005 mfd.)	1.15
1	Bradleyohm	2.00
1	Phone plug50
	Flexible connections40
	Panel 7 x 18.	1.35
	Miscellaneous—bus bar binding posts, bolts, etc.	1.00
		<hr/>
		\$29.40
3	W D-12 tubes	15.00
3	Dry-cells (Burgess).	1.50
3	blocks B battery	6.00
		<hr/>
		\$51.90

The latter tubes seem to vary in characteristics, as it took some shifting of tubes to get

the three tubes sorted out for their best operation. It was found that one tube was decidedly below average as a reflex operator, but functioned perfectly as a detector, and vice-versa with the second tube, while the third will do anything, anywhere. The set is easy to control, simple to tune, and it *does not radiate*.

This particular set is operating about three miles from the center of Cleveland, Ohio—within a mile of WHK, two miles and a half from WJAX and less than 5 miles from WTAM. It operates on a 75-foot single wire antenna, with a 40-foot lead-in, down the brick side-wall of an apartment house, surrounded on three sides by 550-volt trolley lines, and on the fourth side by a 2200-volt power cable—with transformers less than 500 yards away. It is within three miles of WTK, a most pervasive ship-to-shore spark station operating on 600 meters, and apparently in the center of the largest collection of radiating sets with dial-twisting operators in the whole United States—it will get away from everything but the shock excitation of WTK's spark. Nothing can eliminate that.

HINTS ON BUILDING THE SET

IN THE building of these three sets several little kinks have been discovered that may aid in construction of duplicate receivers of this type.

The forms for the spider-web coils are not easy to make, for the best material is hard to handle with the usual tools. They are more or less difficult to find in the regular radio stores, for some unknown reason, but they have been found in the five and ten cent stores in three cities, and are probably carried by all of the stores of that class that carry radio parts.

Three types of these forms have been found: one is made of what appears to be a soft cardboard, much like a double-thick stiff blotter. It is wise to avoid this sort of material—another is made of a $\frac{3}{8}$ " (thick) red vulcanized fibre, and is very good, but the best, if they can be found, are the ones made of $\frac{1}{8}$ " (thick) hard rubber. The size that is best, and which is amply large for the windings specified, has a $1\frac{3}{4}$ " center, 4" outside diameter, and fifteen slots.

It makes no difference in winding

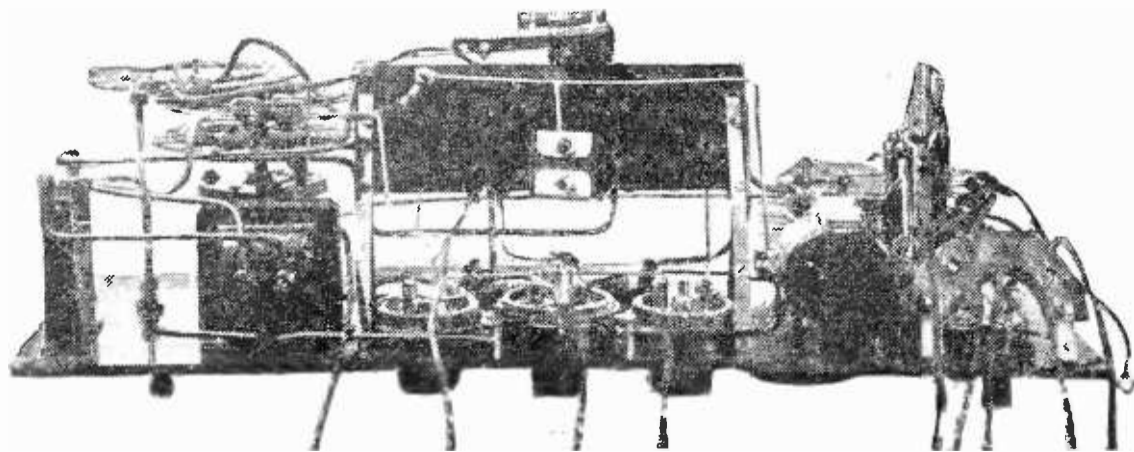

BEHIND THE PANEL

From the under side, showing the spring-brass brackets holding the tube shelf and three rheostats. The neutralizing condenser is in the center. The tickler coil is on the left and the two audio transformers are one on either side of the rheostats

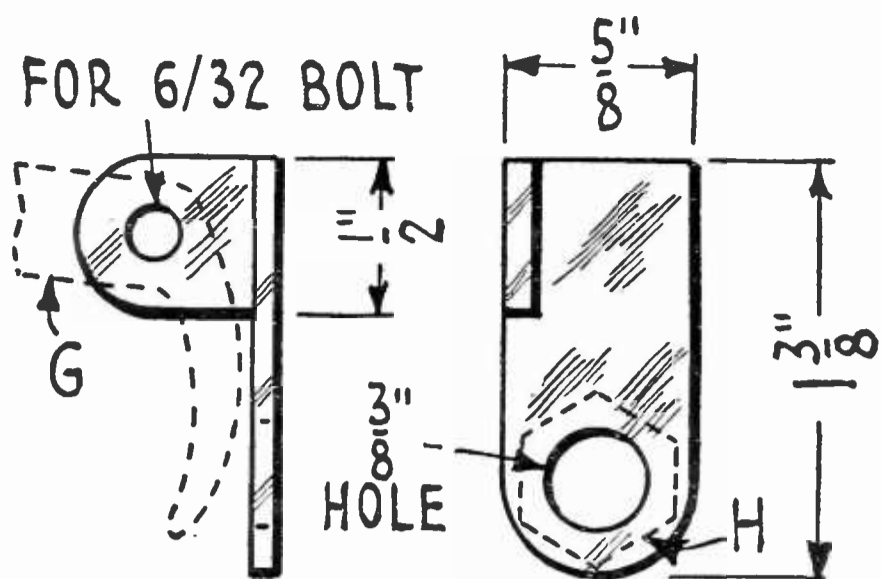

DETAILS OF THE BRACKET F

As shown incorporated in the drawing below. The lever G is #18 gauge brass. Its other dimensions will vary with the location of center of coil S-1

these coils whether they are wound clockwise, or counter-clockwise, *but, whichever direction you choose, wind all of them the same way.* It is a very good scheme to wind them clockwise, leaving the inner terminal wire protruding from the face of the form (the face being the side toward you), and wind in a clockwise direction till the required number of turns are placed, and then bring the outside terminal wire through to the face of the form. Make a terminal out of a $\frac{1}{4}$ "- $\frac{6}{32}$ brass bolt and nut and locate same for the beginning of the coil, about $\frac{1}{4}$ " inside of the windings, soldering the end of the wire in the screw slot—duplicate the process for the outside end of the wire, locating the bolt about $\frac{1}{4}$ " outside of the windings on one of the spokes of the form. Then mark the coil, on the face, with an arrow pointing in the direction of the windings, and when assembling the coils, see that all the arrows are on the same relative side of the coils and all pointing in the same direction.

In the double coil, (N and P) it is well to bring the *outside* terminal of N, and the *inside* terminal of P, to a common terminal bolt, inside the winding circle, and locate the terminal bolts for the *inside* terminal of N and the *outside* terminal of P, outside the winding circle, on two adjacent spokes of the form, and *mark them.*

The wiring diagram should be followed carefully, in every case, but most particularly in the wiring of the filament lead. Do not run this wire to or through rheostats or resistances of any kind—use either square bus bar, or No. 14 hard copper wire, and

run direct from the - A terminal binding post to the - terminal of the filament on the tube sockets (on standard sockets, the - post is the one nearest to the grid terminal—often both terminals are only marked with an F without + and - markings), and then carry it on, if consistent, to meet the other - A connections (on the two-tube set these connections are to the F terminal on the secondary of the transformer, one side of the .005 condenser, one side of the .0025 condenser, and the grid return of the detector tube—the three-tube set has another one—to the second

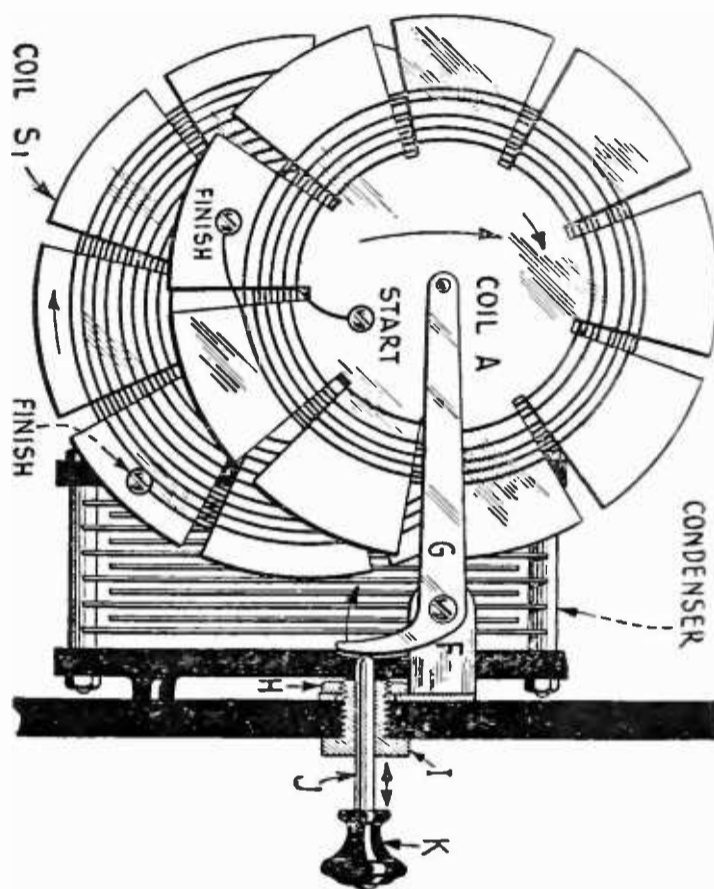

DETAIL OF THE MOUNTING

And coupling of coils A and S-1. H, I, J, and K are nut, bushing, shaft and knob of standard switch lever assembly. J is coated with solder and filed to a sliding fit in bushing I

transformer.) The rheostats, whether you use one or three resistances, if you use them, and the battery switch should all go in the line carrying the A - and B - currents.

In the set described, using two (and three) WD-12 tubes, 22½ volts of B battery seemed to

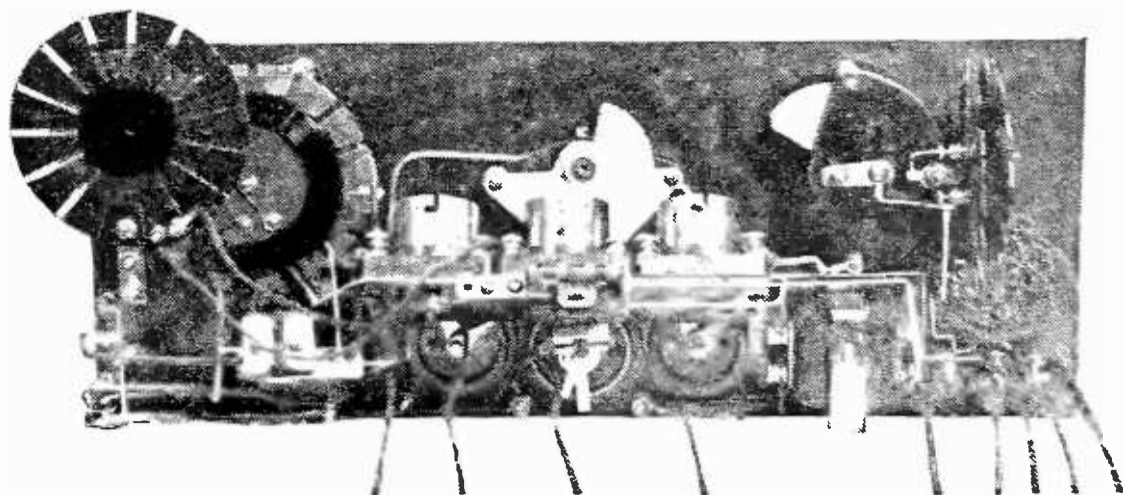

BACK VIEW OF THE RECEIVER

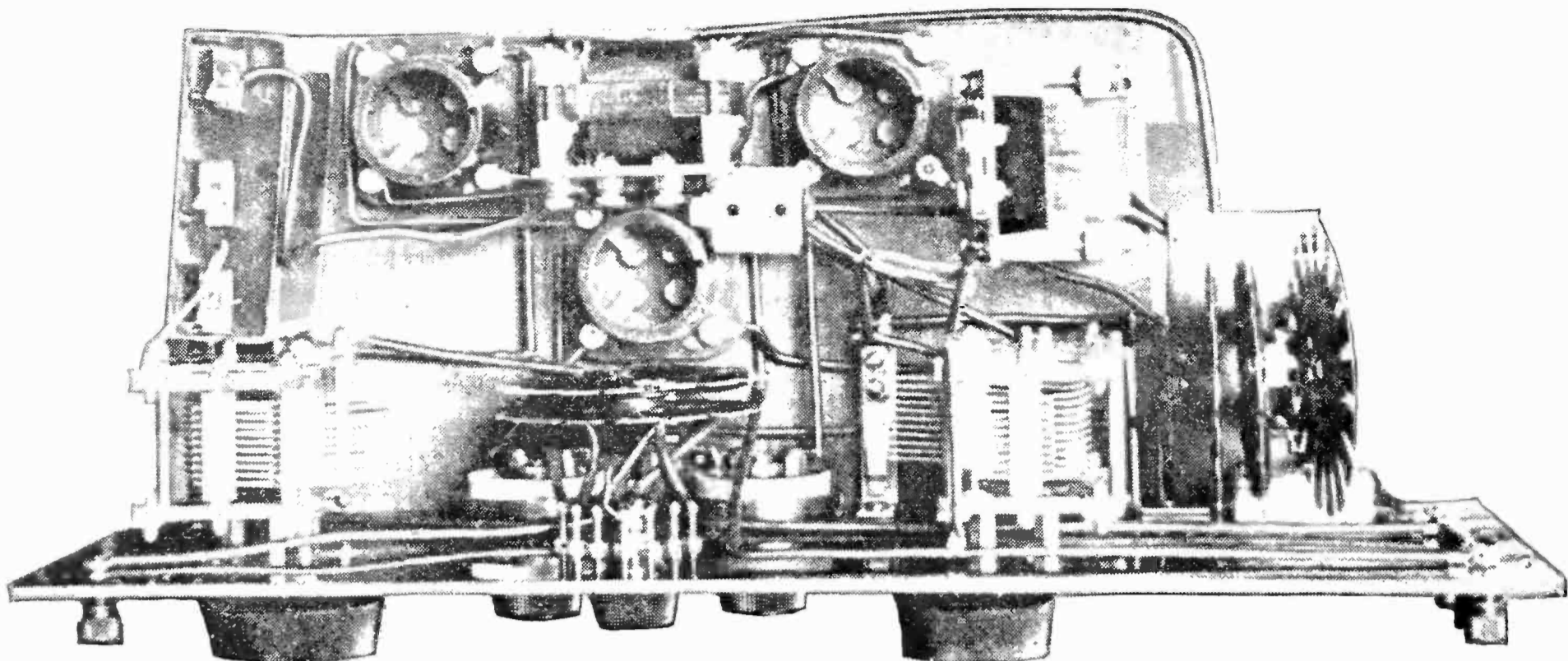

ALTERING THE DESIGN

Several of these three-tube sets have been built in RADIO BROADCAST'S Laboratory and the illustration above shows very plainly that it is not absolutely essential to follow the lay-out suggested by the author

be correct for the plate voltage on the second tube, and both the two-tube and three-tube sets have given splendid results with 45 volts of B on the first (and third) tube. When 201-A tubes

were used in the two-tube set, 90 volts were applied to the plate of the first tube and $22\frac{1}{2}$ volts on the second tube and the results were only slightly better than 45 volts on the WD-12.

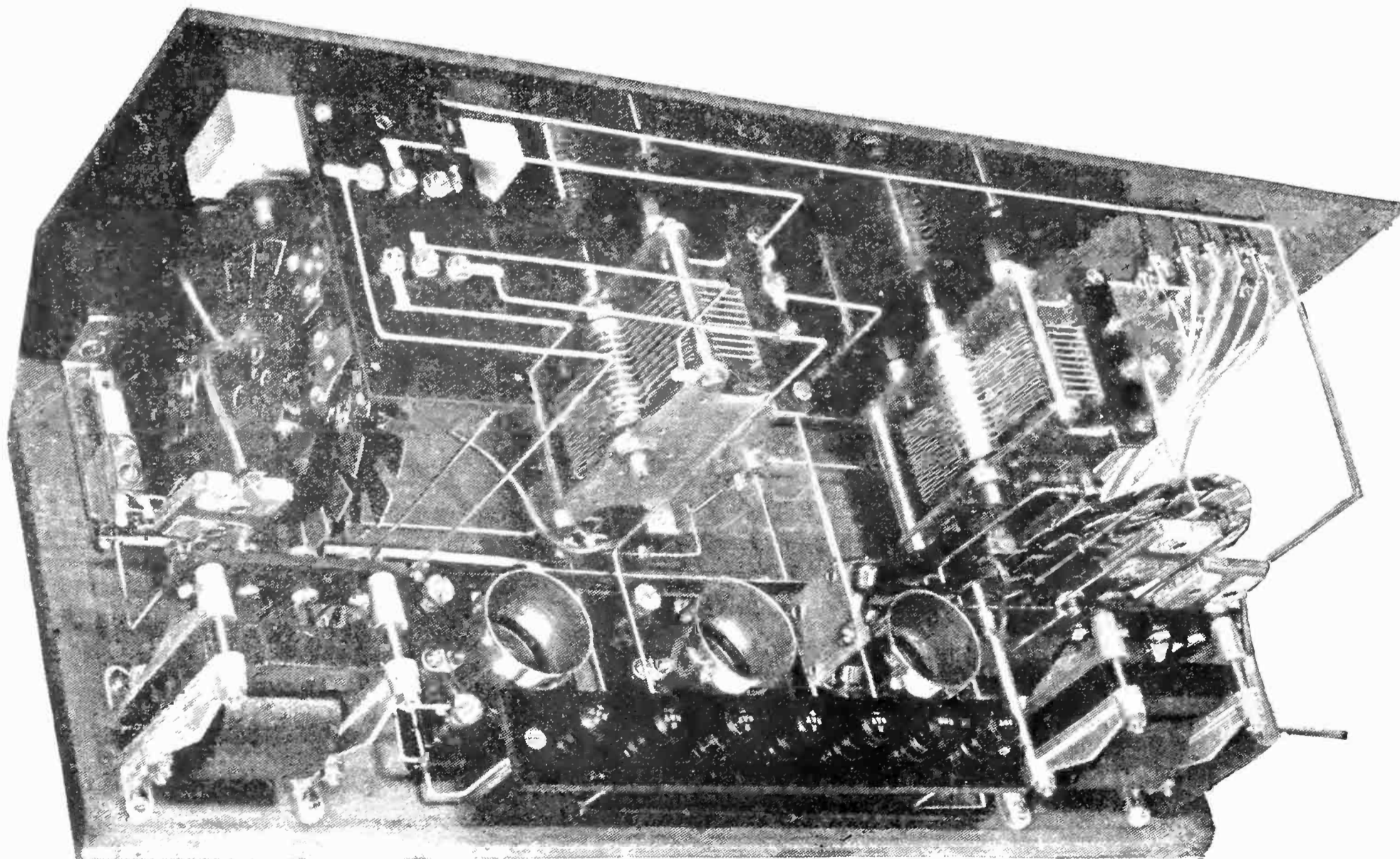

THIS FINE LAY-OUT

Was built under the direction of RADIO BROADCAST by Schneider and Horneij, of New York. The design and workmanship is exceptionally clean cut and workmanlike

~When the "America" Put Out to Sea~
Fog ~Wind~Disaster~and~Rescue.

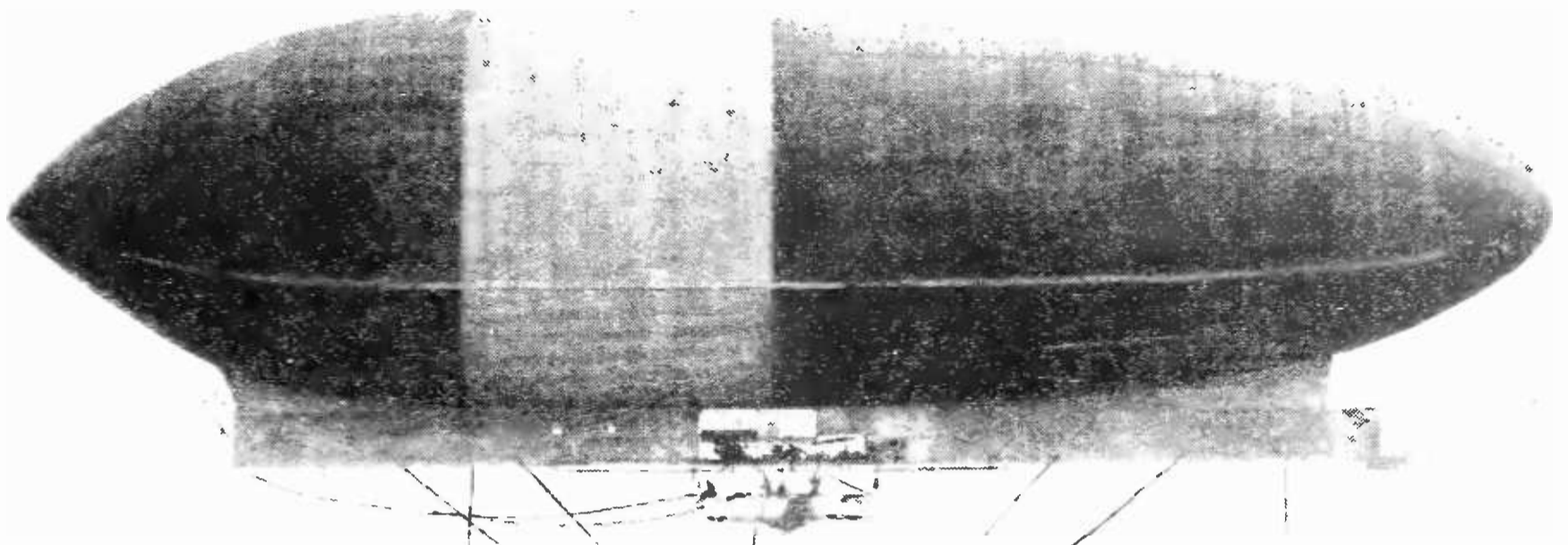

Told by ~ Jack Irwin ~
~ The First Airgoing Wireless Man ~

ON JULY 14, 1919, those two admirable Lieutenants, Alcock and Brown began their airplane trip from St. John's, Newfoundland, which ended with their successful arrival at Clifden, Ireland. On October 10th, 1910, a much bulkier airship and a more numerous crew started to cross the same stretch of ocean, but they were nine years ahead of the progress of invention and failed in their attempt to reach the other shores. This story is particularly interesting at this time because of the "round the world" airplane flights being staged by the U. S. Army Air Service, and others.

"I have often before been approached to write about this eventful voyage of the *America*," writes Mr. Irwin to the Editor, "but have refrained, believing that the story would make more interesting reading later."

IN THE spring of 1910 I received what, at that period in the history of radio, was the strangest assignment a wireless operator ever had. I had returned to New York after a trip to England as radio operator on the old American Liner *St. Louis*. The Marconi Wireless Telegraph Company of America was then a small organization and I was one of the four sea-going operators in its employ (there were only fifteen operators in the company's entire service). To be in charge of one of the four ship stations the company controlled

was considered, in those days, a good job. I was contented with my lot and satisfied with what life offered—a fine ship, good fellows for shipmates, and a pleasant run.

It was then customary, in that small family-like organization, for ship operators to report after each voyage direct to the Chief Engineer of the company, Mr. Frederick M. Sammis. He occupied a similar position to Poo Bah—that extraordinary and versatile character in Gilbert and Sullivan's "Mikado." He acted in almost every capacity. Without any other

thought in mind, except, perhaps, the usual operator's genius for smelling a salary advance, I entered Mr. Sammis' office and made the customary report. It was then I received the jolt he had prepared for me. He nonchalantly inquired whether I was prepared for a transfer to another ship, and as though it was an everyday duty with him, in a few words tendered me the job of operator on the airship *America*, then being constructed at Atlantic City. Whether I jumped at this offer or not I cannot remember now, but I found myself in the course of a day or two in Atlantic City, duly signed on as a member of the crew of a dirigible and committed to make the first attempt to cross the Atlantic by air line.

ASSIGNED TO AN AIRSHIP IN 1910

MY CONTRACT with Mr. Walter Wellman, who commanded the expedition, called for my services not only as a wireless man, but as a general aide, and the months intervening between June, when I joined the crew, and October 15th, when we sailed, found me handling many jobs and assimilating a knowledge of aëronautics. There was also born in me a love for the flying game that has persisted to this day. One of the jobs nearly cost me my trip when the valve on the hydrogen plant, which I was tending, came off in my hand and filled my shoe with a boiling sulphuric solution. I was weeks in a hospital and my substitute had already been selected, but fortunately many delays in the sailing date intervened, with the result that I was able to hobble down to the ship and sail with the originally selected crew.

The *America* was what is known as a non-rigid type of dirigible, cigar shaped. She was 228 feet long and 52 feet in diameter at the central or thickest part. This great gas reservoir was made of cotton, silk and rubber and beautifully tailored, all seams being wide lapped, sewn and gummed, and extra strips cemented over to cover the stitches and prevent leakage of hydrogen. The huge envelope contained when fully inflated, 345,000 cubic feet of hydrogen gas. This lifted a load of 28,000 pounds.

Under the balloon or gas envelope was built a huge steel frame, enclosed with varnished linen, and attached to the balloon by eighty steel cables fastened to what is known as the "relingue," or, in other words, a belt sewn to the balloon about ten feet below its equator and extending its full length. This frame was fashioned of the best steel tubing and wires, strung as a bridge, the whole being 156 feet long, 8 feet wide at the top, V shaped, and at the bottom of the V there was a staunch steel cylinder two feet in diameter, divided into ten compartments, with a capacity of 1,500 gallons of gasoline. Along the top of this cylinder ran a thin boardwalk 2½ feet wide, forming the floor or deck of the car. Celluloid windows were placed at intervals in the linen sides of the car enclosures; and about the engine rooms, amidships, steel screenings replaced the linen. Non-inflammable paint was employed to minimize fire risks. In this car were the crew's quarters, engine rooms, dynamo, and control or navigating bridge.



JACK IRWIN

Who tells his story of the first wireless voyage in the air when Walter Wellman's *America* set out to conquer the Atlantic in October, 1910

THE EQUIPMENT OF THIS PIONEER SHIP

SHE was engined with two motors, one a Lorraine-Dietrich engine driving, at 500 revolutions per minute, a pair of propellers each 12 feet long. The other engine was an E. N. V. 8-cylinder motor, driving twin propellers 10½ feet in length at 750 R. P. M. We also had a small gas engine to operate air pumps for the balloonettes. This small engine acted as a donkey engine for cranking the big engines.

Slung under the central portion of the car was the lifeboat. This lifeboat was then the last word in boat-building. It was built of sewn, laminated mahogany—27 feet long, 6 feet wide, with a depth of 3½ feet amidships. Each end was decked over and made into a water-tight compartment by simply battening down a circular hatch in each deck. Amidships was a spacious cockpit in the center of which was a self-baling device and in the forward end a cubby-hole for the wireless apparatus.

Below the lifeboat, made fast to the long steel car fore and aft, swung the equilibrator, designed to equalize our altitude. This device



© Underwood & Underwood

THE CREW

Of the *America*, photographed near the hangar at Atlantic City, where the ship was built. Left to right, Melvin Vaniman, constructor, and chief engineer; Murray Simon, navigator; Walter Wellman, head of the expedition; Fred Aubert and Louis Loud, assistant engineers. Wireless operator Irwin burned his foot in an explosion of hydrogen and was not in the photograph

also served for our radio ground connection and provided storage for our reserve gasoline supply. This equilibrator consisted of a great many steel cylindrical tanks, concave and convex at either end, threaded like cotton spools on a 340 foot $\frac{1}{2}$ -inch steel cable.

The radio apparatus, designed by Mr. Sammis, was considered the ultimate in equipment in those days, but how I have laughed since, and yet marveled at its simple efficiency. Those who read this will also smile at the description of the set, nevertheless, pause and consider that this was the first time that the radio engineers of that day had been called upon to equip an airship of any kind. We had nothing to guide us—no precedent to follow. There were innumerable problems to solve, the greatest being the elimination of fire hazard by sparking in the rigging adjacent to the gas container. Hydrogen gas, when combined with a certain mixture of air is a mighty explosive, as I was to learn in the subsequent *Akron* expedition. Other problems to overcome were limitations in weight and size. Like radio arrangements on any ship in those days, the wireless accommodation was given the least consideration at the time of drawing the ship's plans. Radio was indeed an experiment. The events of the voyage changed this attitude.

THE FIRST AIRSHIP RADIO SET

BECAUSE we had absolutely to eliminate fire hazards the transmitter was of the inductively coupled spark type and constructed to provide exceptionally loose coup-

ling. A specially built induction coil was installed inside a square cabinet about 12 by 12 inches by 18 inches high. This cabinet was hinged six inches from the top. In the lower part with the induction coil the condensers and spark gap were installed. The leads from the spark gap and the condenser were taken to the primary of the oscillation transformer, consisting of a few turns of heavy wire wound round the inside of the lower portion of the cabinet. The secondary of the oscillation transformer was wound round the hinged lid of this transmitter cabinet, and variation of the coupling was obtained by the raising or lowering of the lid. One lead of this secondary was taken to the car of the airship and made fast to the tank, making the entire metal and wiring of the great car the antenna. The other lead from the secondary of the oscillation transformer was made fast to the equilibrator which was used as a ground when trailing on the sea, and as a counterpoise when suspended out of the water, care having been taken to insulate it from the car to which it was anchored. In series with the ground connection we inserted a small air-gap to indicate antenna radiation as we possessed no reliable radio-frequency meters in those days!

Theoretically, in arranging the coupling of the transmitter it was necessary to give careful attention to the fact that the dragging equilibrator, which formed part of the open oscillating circuit, would be continually varying in length, dependent upon the lifting power of the hydrogen in different degrees of temperature,

thus causing a corresponding variation in its natural period. A very loose coupling was finally determined upon in order to nullify as far as possible the effect of the open oscillatory circuit upon the closed. We later had to cast aside all these fine theories for a more simple expedient.

In actual tests on the ground it was found the original induction coil was not very efficient and a standard Marconi 10-inch coil was added to the set, the original being retained as a spare. A battery of Leyden jars was also provided for a condenser. Tests proved that this assembly was capable of transmitting a distance of from 50 to 75 miles in daylight without difficulty, and as we planned to keep to the steamer lanes

across the Atlantic this was considered satisfactory.

The actual power used was approximately 250 watts. The energy was obtained from a small storage battery of 24 volts, which, in turn, was charged by a small dynamo belted to one of the main engines. This outfit also supplied current for a few electric lights in various parts of the ship.

OUR RECEIVER—SIMPLICITY ITSELF

THE receiving apparatus was simplicity itself and consisted of a single circuit containing a variable inductance, a variable condenser and a specially built magnetic detector. These were arranged on the baseboard of the

wireless cupboard and connected with flexible leads. As I have previously remarked, we hoped to stay on the transatlantic steamer tracks. Distance reception and selectivity were of secondary consideration. As ship and shore stations in those days worked on the wavelength which gave them the greatest efficiency (this was before the London Convention and U. S. Radio Laws), a receiver broad in its tuning was desirable.

With this equipment installed, the *America* was finally ready for the hop-off. The start had been scheduled for August or early September and trial trips had been planned, but due to annoying delays the ship was not ready for the air until October. Since it was so late in the year, the proposed trial flights were abandoned.

OCTOBER FIFTEENTH—4 A. M., FOG, AND THE START

ON THE morning of October 15, 1910, I was awakened about 4 o'clock and told to go aboard. There was not a breath of wind. A dense fog dripped down over everything. The crew of the ship consisted of Messrs.

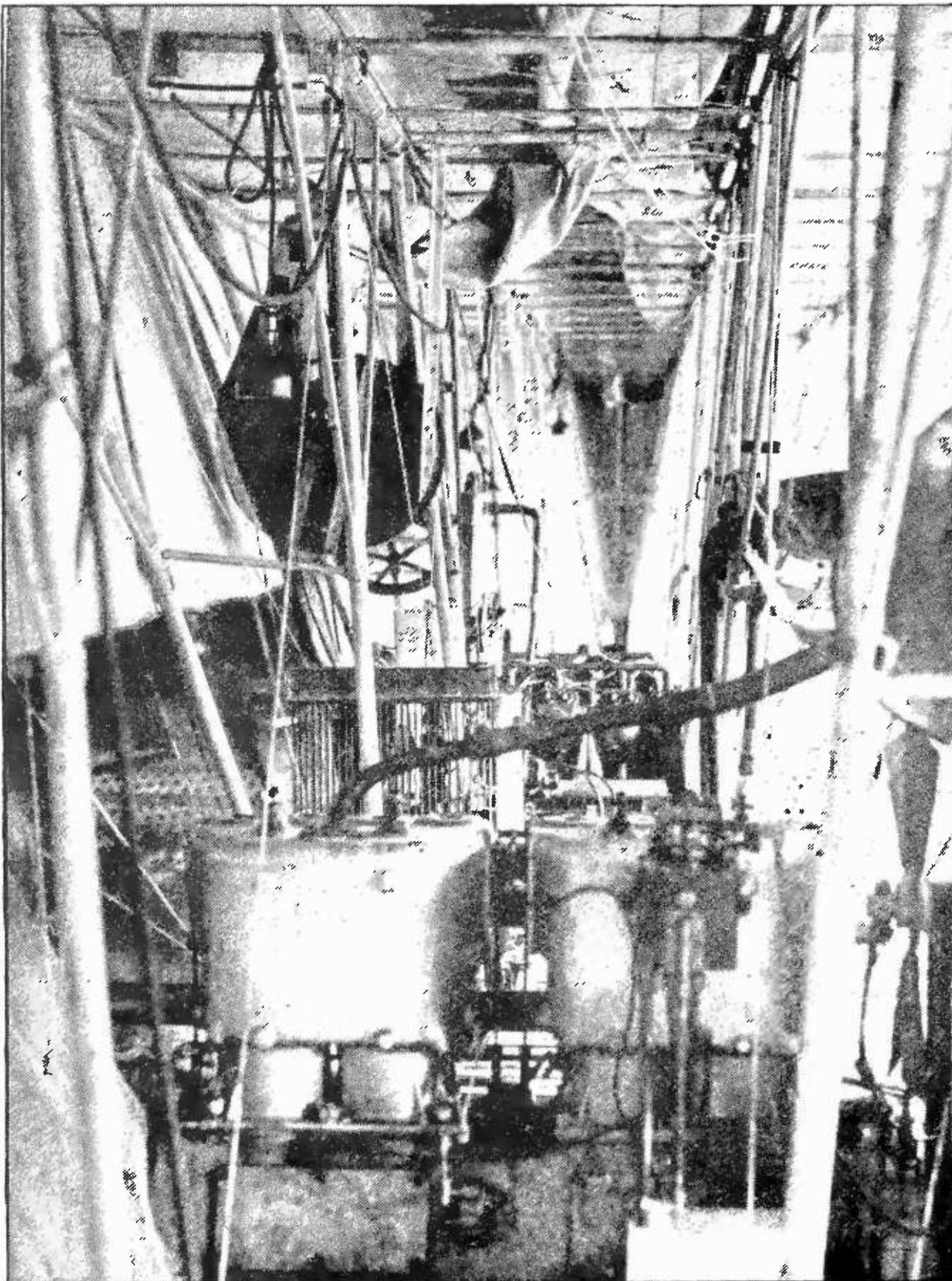

© Underwood & Underwood

ENGINE ROOM

Of the ship, looking aft. The crew had very little space for promenades

Walter Wellman, commanding; Melvin Vaniman, chief engineer; Louis Loud and Fred Aubert, assistant engineers; Murray Simon, navigator; and the writer. With the help of a few hundred police and firemen we proceeded to launch the largest non-rigid airship ever constructed. At 8 A. M. all was in readiness and the crew climbed aboard. The last to embark was our mascot, a pretty foundling kitten that had been a pet around the hangar. The crew had jokingly told visitors that the kitten was going along with us and just as the word to "let go" was passed, somebody in the crowd threw the kitten into the lifeboat where I had taken my station. Up we went and the cat was one of us! Kitty, at first, appeared scared and raised an awful "holler," but he (yes, it was a Tom!) soon settled down. In the long days and longer nights that followed, I will admit I was grateful for that kitten's affectionate company. It was always to be found cuddled up to me in the wireless corner of the boat.

We did not start our motors immediately, but preferred to be towed out through the narrow entrance called The Inlet, at Atlantic City. Reaching the open water our tug cast off our line and we started our engines. We were flying at an altitude of only 200 feet, with a portion of the equilibrator trailing on the surface of the ocean. This low altitude was due to the heavy cargo we carried and the fact that the morning was cold and wet. The moisture of the fog contracted the hydrogen with a consequent loss of lifting capacity.

During the first hour of the flight I was busy making various adjustments. Listening in, I could hear "Bobby" Miller, at the old United Wireless station "AX," on Young's Pier at Atlantic City calling "W," the call letter assigned to the *America*. The signals dissipated any doubts I may have had regarding the receiver.

For months we had discussed the possibility of sparking in the rigging and the risk of burning a hole in the fabric of the balloon, so when the moment came to "sit" on the key of the transmitter, I think I can be pardoned for my nervousness. I am sure I have experienced the moment that a suicide passes through when he is about to pull the trigger. Stationing the crew in different parts of the ship to report any sparking, I threw in the sending switch and answered Miller's repeated calls. I shall never forget my expansive satisfaction when he came back and told me my signals



THE CAT AND THE ENGINEER

The homeless Atlantic City cat which unwittingly acted as mascot on the voyage, being comforted by chief engineer Vaniman

were clear and strong. I had opened the coupling of the transmitter for a minimum radiation; therefore, with only a few miles separating us from the nearest station, I had established radio communication, for the first time, between a ship of the air and the earth, but I had plenty of power in reserve and knew that we had reliable communication within certain limitations. Mr. Wellman, during the time I had been engaged in these preliminary tests, had been sitting at my elbow, anxiously waiting the result, but as he afterwards wrote in his book describing the trip, he could tell by the pleased grin on my face that we had succeeded in establishing communication.

FIRST SENSATIONS IN THE AIR—NONE

BY REFERENCE to my log, I find that communication was established with AX at 10.30 A. M. and that at 11.05 A. M. I had sent eight messages to Miller. At 12.30 P. M. I made an entry of receiving two messages from AX, while at 1.30 P. M. there was this notation in the log, "Received one message and sent two to Atlantic City. Everything going fine, sensation very fine, all happy." Thus was the first airship traffic conducted, and it had soon developed into the ordinary routine. I had been very busy, these hours, without time to reflect upon my strange surroundings or give thought to the unusual experience of flying.

I have spent hundreds of hours in the air since and been asked innumerable times what my first sensations were, but I can truthfully say I cannot recall them, if I had any. My only anxiety was regarding the success of the installation of wireless; once that was assured I felt nothing but elation. While I was busy at the radio key, successfully maintaining constant touch with Atlantic City, things were not going so smoothly with the engineering department of the ship.

After several hours in the air the dense fog in which we started condensed upon the huge surface of the dirigible, adding a great weight to an already overloaded ship. Instead of steadily rising, as the heat of the sun increased and expanded the gas, we slowly descended and lost altitude. We were compelled to jettison some of the cargo. Due, also, to the lack of trial flights, the engines required tuning and we proceeded very slowly during the morning of the first day. Several times during that morning either one or the other of the engines had to be stopped, caused by sand in the bearings. Our hangar at Atlantic City was in a most exposed spot where every wind that blew brought clouds of sand. However we continued to make progress.

At 3.30 P. M. on that first day, I received my last message direct from Atlantic City. At that time I find that a notation in the log states that I was no longer able to hear him, because his signals were weak. The motors made a fearful noise. The only means I had of deadening the sound of those big engines was the slight protection provided by the cotton battens, I had fashioned. From then until 8 P. M., with the exception of intermittent motor trouble, the voyage was uneventful. At that time, still in a dense fog, we almost ran into a large sailing ship. So close did we pass that we could see the crew running round the decks. Later we passed very close to a large steamer, which we eventually learned was the *Coamo*. From time to time I tried to get into communication with various shore stations, without success. It is quite possible that some of them answered me, but the engines killed anything but the very strongest signals.

AN ENGINE GONE BAD

DURING the night, our best engine had to be stopped, permanently out of commission. It appears that the bearings of the propellers had broken, causing one of them

to wobble alarmingly. Up to this time there had been no wind at all, but now it began to freshen up a bit which drove us eastward, but in a northerly leeway. The fog still persisted and we were compelled to jettison some fuel to prevent descending into the sea. Another danger which became apparent when night fell was the stream of sparks from the exhaust. We were afraid that they would cause an explosion and Wellman wanted to stop the remaining engine. Vaniman, however, talked him out of this, explaining that we had been running all day and that, if we stopped the engine we would undoubtedly drift over Long Island. Furthermore, the balloon by this time was so saturated with water from the condensed fog that we ran little risk of fire. So, through all that night we proceeded under one engine. The engine that had gone back on us was the one to which the dynamo was belted and that meant that we would be unable to charge our battery. With this in mind, I began to hoard the "juice" and used the wireless only when positive that there was something to use it for. As subsequent events proved, it was well I did.

At 5.05 A. M. on the 16th, my log shows that the engines had stopped and that I was listening to all stations talking about us and calling W. I heard the Sagaponack (Long Island) station inform Siasconset that we were 60 miles South of Scotland Light at 6.50 P. M. the previous night when we had been sighted by a steamer and reported by radio. All this time the wind was steadily increasing but was in our favor and we made such good time that we decided to allow our remaining engine to cool off. I waited until Siasconset station was very strong before I attempted to communicate. At 10.35 A. M. I established communication with SC (Siasconset, Nantucket Island) sending him several messages. We were very close to that island during the day, so close, indeed, and so strong our signals, that I afterwards learned that the boys at the stations ran outdoors to try to sight us.

Our expedition had been financed by several newspapers and Mr. Wellman, a newspaperman himself, commenced to file voluminous messages to them. I sent the short ones, but as they became lengthier I protested that the batteries were running down and that we should conserve our power in case we needed help. He promptly agreed with me.

The wind now increased to a gale and began to bear us southeast. When night fell we

again experienced trouble in remaining in the air. We were compelled constantly to throw supplies overboard.

C Q D

THAT night I attempted to obtain assistance, calling C Q D, which at that time was the signal of distress. Our engines were now useless. The voyage had failed and our one concern was to get away with our lives. I early realized that there was no hope of assistance while we were in the air and that we would have to take to the lifeboat. However, with the sea then running and the gale blowing, we simply had to stay in the air. Engineers Loud and Aubert commenced to take the large motor apart and throw it overboard, to lighten the ship. At daybreak on Monday, the third day out, I find I made a note reading, "7 A. M. All ready during the night to leave in the boat, but the breeze too strong for launching. Listened-in and heard the S.S.

Main (German) very strong. Now hear Cape Sable sending a message to some ship for us. Copy it. It is from the *New York Times* and is about the weather."

At 7.20 that morning our navigator took his first sight for position and made us in Longitude 65.51 West. This was 210 miles east of Nantucket. We were steadily drifting south in a beautiful sunny morning. The warmth of the sun took us upward, indeed, so fast did we rise that we had to let some of our gas out to steady our ascent. It was about this time that I received the greatest scare of my life. Mr. Vaniman in pulling the valve cords to release the hydrogen, pulled on the wrong control and we came down in such a rush that it looked as though we were to be emptied into the sea. Mr. Wellman and myself were in the lifeboat, which, slung as it was under the car, would be the first thing to hit the sea. Without a word we made for the ladder leading to the car above. It was then I forgot about

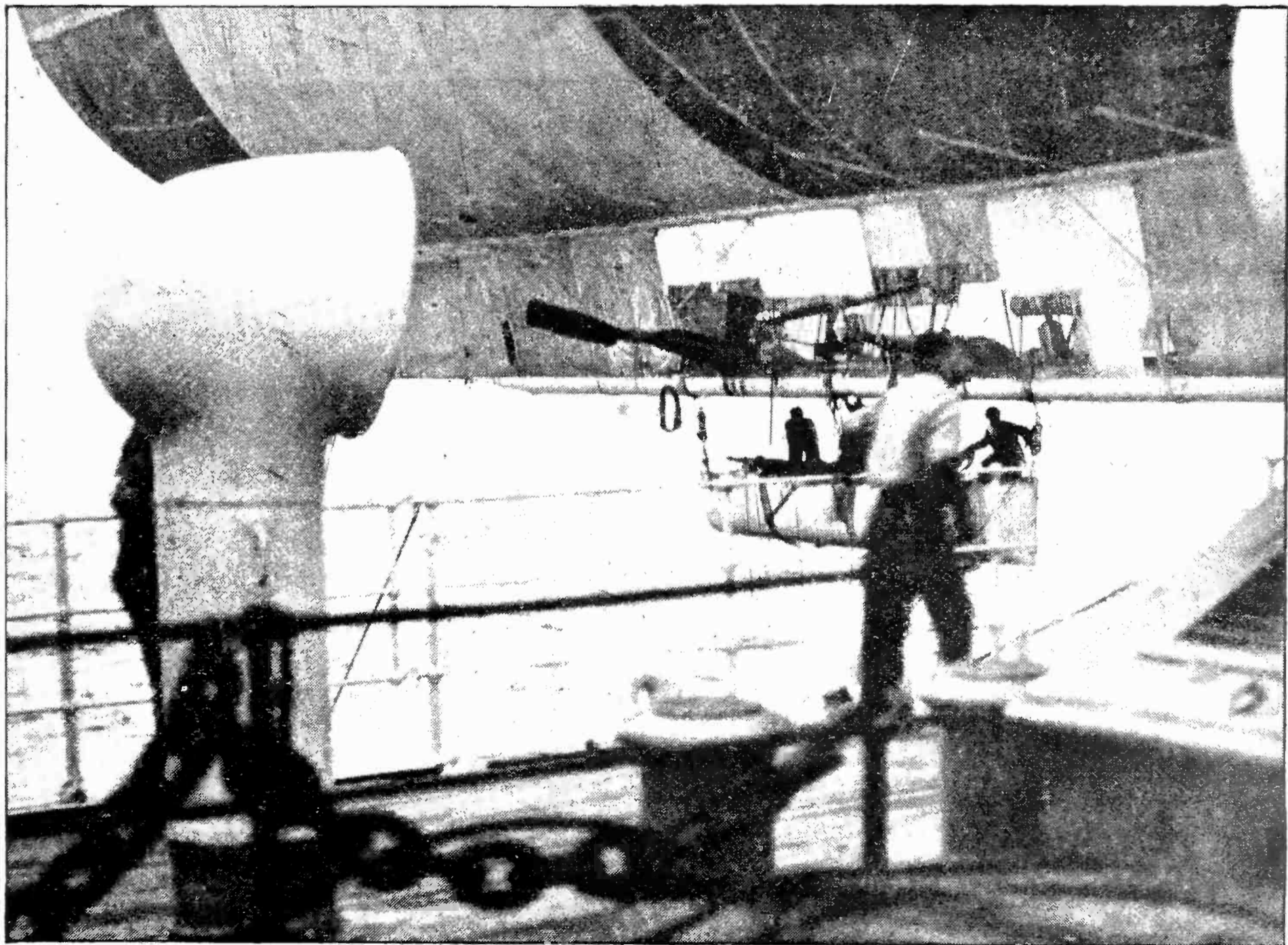

© Charles H. Huesgen from Underwood & Underwood

"AIRSHIP OFF THE PORT BOW, SIR"

This remarkable photograph was taken from the deck of the rescuing ship *Trent*, which picked up the six men in the open ocean. The crew of the airship can be seen preparing to release the clutches which held their special lifeboat

my injured foot. I went up that ladder like a monkey but when I had reached the car above, I found the excitement was over, we had bounced off our equilibrator which had acted as a bumper on the sea. We made a series of long bounces much like a bouncing tennis ball. Mr. Wellman, who had in the meantime got caught in the manhole in the bottom of the car, with his head and shoulders above and held fast under the car by his projecting hunting knife (we each carried one), was not so happy. He did not know that the danger had passed. He called for assistance to extricate him and Loud and myself, laughingly, released him. I was laughing through reaction after the previous terrifying moments, but Mr. Wellman in a story he wrote after our return to New York, said "Irwin laughed in the face of death." Thus are heroes made!

From that time on, we drifted in a southeasterly direction. From my log I find that I listened in all day and into the evening. The last note made in the air in the radio log reads:

"7 P. M. Hear wireless stations working from Cape Sable to the Southern States." In that early day, that meant that I heard just about every station in North America.

The following, taken from my log, tells the remainder of the story:

"October 18th, 1910. Notes made after arrival on board the Royal Mail S. S. *Trent*, made from memory and the log of the *Trent's* wireless operator.

"Remained on watch until 3 A. M., 18th, listening to various stations working, static very bad. Unable to read Cape Cod but hear him working. I turned in at 3 A. M., but was awakened about an hour later by calls of a ship in sight. Descended into the lifeboat and called C Q D. Nothing doing. Then got an electric torch and commenced calling in Morse lamp fashion. Was eventually answered by the *Trent* and signalled him that we were in trouble and required help. Also conveyed to him that we were equipped with wireless. The *Trent's* operator was awakened, and he called us."

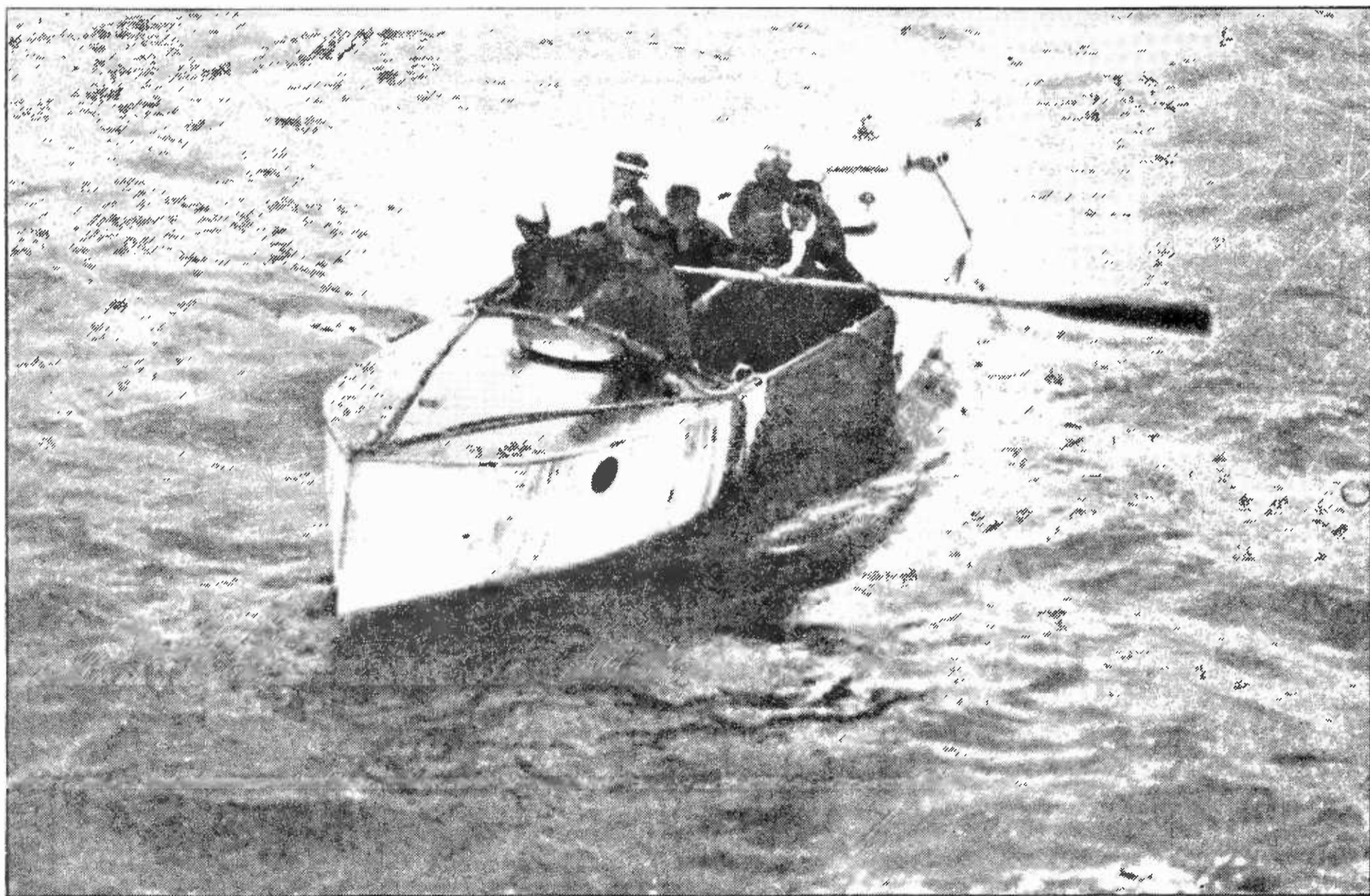

© Charles H. Huesgen from Underwood & Underwood

"HEAVY ON THE STA'BOARD OAR"

The staunch lifeboat of the *America* being pulled toward the rescue ship which was summoned by wireless. This was the first time in aeronautical or marine history that wireless had been used in this spectacular way. Thus ended the Wellman air voyage across the Atlantic after three days of struggle against great odds. Operator Irwin is wearing the straw hat and seated on the starboard side of the boat

WHEN WIRELESS
STEPS IN TO RESCUE

AS I had my head phones on all this time, I answered him and instant radio communication was established. I am indebted to Mr. Louis Ginsberg (the *Trent's* operator) for copies of the following messages which were copied and sent by him; I did not do so, merely reading out his messages to Mr. Wellman as he sent them.

To the *America*—Do you want our assistance?

To the *Trent*—Yes. Come at once, in distress, we are drifting, not under control.

To the *America*—What do you want us to do?

To the *Trent*—Come ahead full speed, but keep astern, we have a heavy tail dragging.

To the *America*—O.K. Am standing by wireless in case of trouble.

To the *Trent*—You will pick us up at daybreak, you will be better able to see us then.

To the *America*—O. K.

To the *Trent*—Come in close and put your bow under us, we will drop you a line but do not stop your ship as you will capsize us.

To the *America*—O. K.

To the *Trent*—Who are you and where bound?

To the *America*—S. S. *Trent* bound for New York.

To the *Trent*—Have one of your boats ready to launch, as we will probably capsize when we launch our boat.

To the *America*—O. K. boat manned.

To the *Trent*—We are going to launch the boat, stand by to pick us up.

Wireless communication then ceased. I cut

MARCONI WIRELESS TELEGRAPH CO. OF AMERICA		6084
STATION PROCES-VERBAL		Oct 18 1910
TYPE	REMARKS	INITIALS
To RNR.	Who are you and where bound?	
To W.	S/S Trent for New York.	
To RNR.	Have one of your boats ready to launch as we will probably capsize when we launch our boat.	
To W.	OK boat manned.	
To W.	Are we gaining on you?	
To RNR.	Yes, we are getting ready to launch.	
To W.	Shall we stop for you?	
To RNR.	Don't stop we will drop a sea anchor and try and check our ship.	
To RNR.	We have a motor going above us. Can't hear your signals now. Will say when I can. Airship ready to bring her down level.	
To W.	We are going full speed waiting for your orders.	
To RNR.	We are going to launch boat stand by to pick us up. Wireless then closed.	

I then cut aerial and earth wires put watertight doors on the opening of the wireless cupboard & stood by. The boat was successfully launched, a most dangerous operation. We were going 15 knots an hour with the boat swinging beam on to the sea and behind the ton and half trailer composed of heavy tanks of gasoline.

At the signal let o both clutches holding the boat were jerked. They acted beautifully, the boat fell into water, lunched gunwale under, then righted the equilibrater (trailer) hit Mr. Loud (1st Asst. Engineer) & myself and stove a small hole in the wireless compartment of the boat but did not injure either of us or impair the stability of our boat.

The greatest danger of the whole eventful three days now occurred. The *Trent* was following full speed right in our wake and she bore right down on our lifeboat for a few seconds which seemed hours. It appeared we were to be cut in two. I prepared to jump overboard and swim clear of the propellers of the big ship, but fortunately at the instant I thought to do so the *Trent* cleared us and we grazed along her sides.

After two or three attempts to row to the ship with two small oars we waited, wallowing in a heavy sea, for the ship to come about. This she did and ranged at slow speed alongside us. Lines were thrown but although we hung on the speed was too great for us to hold on and again we were left astern. Once more this manoeuvre was executed and we got near enough to the liner to row the boat close enough to catch a line.

We came alongside and climbed aboard by a rope ladder.

All wireless gear saved.

J. R. Irwin, Operator.

THE LOG OF THE AIRSHIP "AMERICA"

A photograph of the last page of the log, which every radio operator must keep as a record of the transactions of the station. The call letters of the stations are in the left-hand column. R N R is the call of the English ship *Trent*, which rescued the *America's* crew of six. W was the call used by the airship. This is the first time this highly interesting document has been printed

the antenna and ground wires, put the water-tight doors on the wireless cupboard, and stood by. The boat was successfully launched, a most hazardous operation. We were drifting fifteen miles an hour, with the boat swinging beam on to the sea and behind us the ton-and-a-half trailer. At the signal to "let go" both clutches holding the boat to the car were jerked. The boat fell into the water, lurched gunwale under, then righted. The trailing equilibrator hit us, stove a hole in the boat above the water line, and bruised Loud and myself. The *Trent*, ploughing along at 16 knots, almost ran us down. We fell astern and waited for the steamer to come about and pick us up. After considerable maneuvering she came alongside, and with her derricks, lifted the lifeboat aboard. Thus was I able to save the entire wireless equipment.

The *America*, with the weight of the lifeboat and crew released from it, shot up in the air several thousand feet and soon drifted out of sight. Before leaving her we opened the gas valves so that, eventually she would come down on the sea and not cause damage by landing

or dragging over a city. We never heard of her again.

Nobody but those who have experienced it, can imagine the feeling we had upon arriving on the *Trent*. We were overwhelmed with kindness. Two days later we arrived in New York where we found that our attempt to reach Europe in an airship had attracted extraordinary interest. We had occupied the front pages of the press of the world for several days. We failed, but in later years I had the gratification of knowing that other Americans accomplished what we had attempted and that the N C 4 "delivered the goods." One thing we had done. We had demonstrated that communication by radio from airships to the ground was easily accomplished and presented no great difficulties. While these pages were being written the press published the news that the *Shenandoah*, giant navy dirigible, had had one of her six engines removed in order to make a place for an additional radio equipment that would be powerful enough to reach shore from any position. This is, indeed, a tribute to the efficacy of radio in the air.

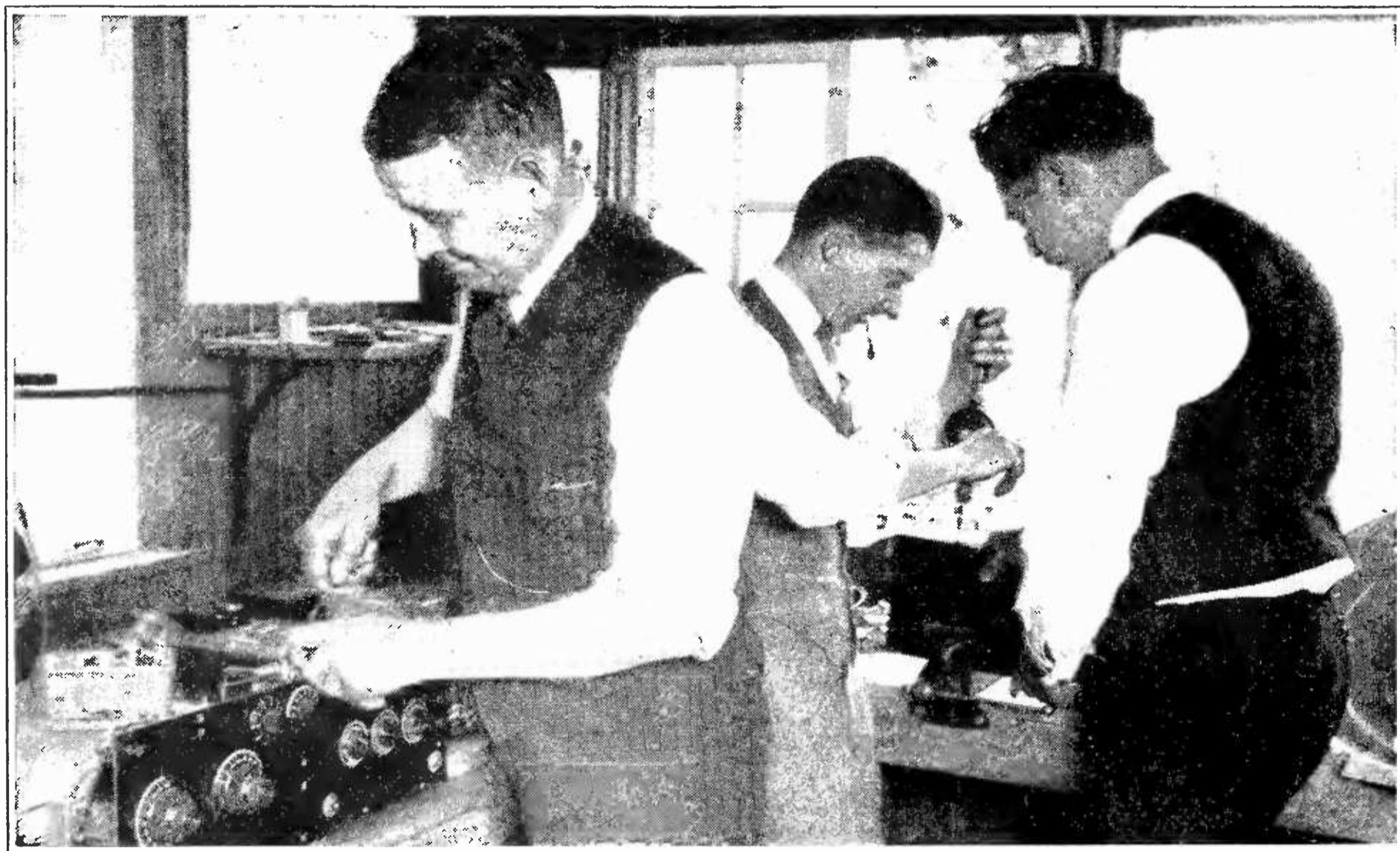

CAPTAIN JACK IRWIN

Preparing a "Knock-Out" receiver in RADIO BROADCAST'S laboratory for the RADIO BROADCAST COVERED WAGON, in which he is engaging in another radio adventure, as interesting in its way as the voyage of the *America* which he describes in this article. The Wagon will visit cities and towns everywhere throughout the country, spreading the gospel of radio, and has already started on its way West. Arthur H. Lynch, editor of this magazine, is in the center and John B. Brennan, technical assistant, is at the extreme right

Solving the Problems of the Neutrodyne



One of Professor Hazeltine's Aides Discusses the Set—How to Neutralize Stray and Over-All Capacity in Two- and Three-Stage Radio-Frequency Sets—A Radio Club of America Paper



BY J. F. DREYER, JR.

Engineer, Hazeltine Research Corporation

A YEAR ago Professor Hazeltine described before the Radio Club of America his method of tuned radio-frequency amplification. The objectionable and uncontrollable regeneration caused by the capacity which couples the grid and plate circuits of the vacuum tubes had previously stood in the way of a successful amplifier of this type. The receiver employing this method, which he called the Neutrodyne, removed this obstacle by neutralizing the objectionable coupling due to this capacity. Since that time the Neutrodyne receiver has become very popular; and many amateurs have constructed their own receivers, though often with much difficulty in completely attaining the results of which a factory built Neutrodyne is capable. It is the purpose of the writer to describe the different problems which have presented themselves and to explain how these problems were solved.

In order to form a basis for further discussion, it is necessary again to explain the fundamental theory of capacity coupling neutralization. Fig. 1 illustrates a vacuum-tube amplifier whose grid and plate circuits are both tuned to the desired frequency. A passing radio wave causes a minute current to flow through the grid circuit C_1L_1 . This circuit being tuned to the wave frequency, and thus having a high impedance, builds up an appreciable voltage which is impressed on the grid of the vacuum tube. By the relay action of the tube a similar current flows in the plate circuit. As this circuit is also tuned to the wave frequency, it builds up a still higher voltage which is passed on to the next tube. Without neutralization, regeneration takes place due to the capacity coupling the grid and plate circuits. That is, the voltage built up in the plate circuit of the tube causes a current to flow through this

capacity C^1 , which reinforces that already present in the grid circuit due to the passing wave. This may be sufficient to cause self-sustained oscillations which, unless very carefully controlled, completely destroy the value of this form of amplification.

HOW THE HAZELTINE PRINCIPLE IS APPLIED

THE Hazeltine circuit as embodied in the Neutrodyne receiver eliminates this effect in the following way: A third coil, L_3 is coupled closely to L_2 as shown, so that one end (the other end being grounded) varies in potential in exactly opposite phase to that of the plate end of L_2 . A small condenser, C_n is then connected between this end of L_3 and the grid of the tube. If C^1 , C_n , L_2 , and L_3 are properly related, the following action occurs: a current still flows through the plate-grid capacity, C^1 due to the voltage built up in L_2 , but this current no longer enters the circuit C_1L_1 for the reason that the combination C_nL_3 demands exactly the same current. This current therefore, instead of flowing down through C_1L_1 passes back harmlessly through C_nL_3 to its source at the plate of the tube.

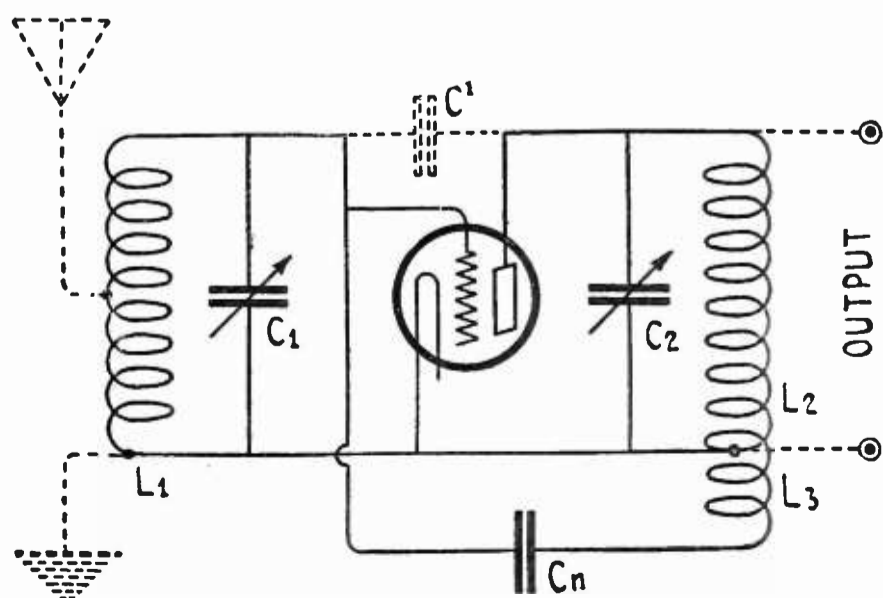

FIG. 1

Circuit diagram illustrating the neutrodyne principle

The conventional Neutrodyne receiver employs this circuit in a slightly modified form. There are usually four or five tubes employed, two radio-frequency amplifiers, detector, and two audio-frequency amplifiers. Or perhaps one audio tube is omitted and a radio tube used in place of it by the usual reflex method. The circuit of a five-tube receiver is illustrated in Fig. 2. Three separate rheostats are provided, one for controlling the filament temperature of the radio-frequency tubes, one for the detector and one for the audio frequency. The radio-frequency rheostat provides a volume control for cutting down the strength of the signal, which is advisable when the user is located near one of the more powerful broadcasting stations. The other two rheostats are used in the ordinary way.

The two radio-frequency amplifiers (employing the Neutrodyne principle) are different from the one illustrated in Fig. 1 in that instead of tuning the plate circuit, a secondary coil closely coupled to the primary or plate coil is tuned. This allows a step-up ratio to be employed which gives greater amplification and selectivity. Also if the two coils are connected properly—that is, with plate of one at the opposite polarity to grid of the succeeding tube, then a portion of the secondary coil may be used in place of a third or neutralizing coil. Referring to Fig. 2, the neutralizing condenser C_n is connected from the grid of tube No. 1 to a tap on the secondary of the transformer unit B. The neutralizing condenser for the second tube is connected in a similar manner from the grid of that tube to a tap on the secondary of the unit C. The correct location of these taps depends on the value and range of the neutralizing

condensers used—that is, if the tap on coil B is moved up so as to include twice as many turns between it and the ground potential end of the secondary coil, then the capacity required at C_n will be only one half (approximately) as large as before. In this connection it should be pointed out that many receivers constructed from parts but which are not provided with a proper panel shield are very difficult to balance due to their inherent capacities. Referring again to Fig. 2, any capacity between adjacent grids tends to neutralize the tube capacity even more effectively than does capacity at C_n . This capacity will always be appreciable because the fixed plates of the variable condensers C_1 , C_2 , and C_3 are connected directly to the grids of the tubes and therefore present large surfaces which act as the electrodes of condensers connected between them. As mentioned above, it is possible for these capacities to more than neutralize the tube capacities. If this is so, it is impossible, of course, to obtain a balance by a further addition of capacity at C_n . This condition may be eliminated by adding capacity at C^1 or better still by minimizing the inherent capacities by shielding. A grounded metal shield properly mounted on the panel cuts down the external field of the condensers sufficiently to make a balance possible.

ADJUSTING THE NEUTRALIZING CAPACITY

THE actual adjustment of the capacity C_n is accomplished as follows: A strong signal either from a near-by broadcasting station or from a local oscillator is impressed on the antenna coil. The condensers C_1 , C_2 , and C_3 are then tuned to this signal with the filaments of

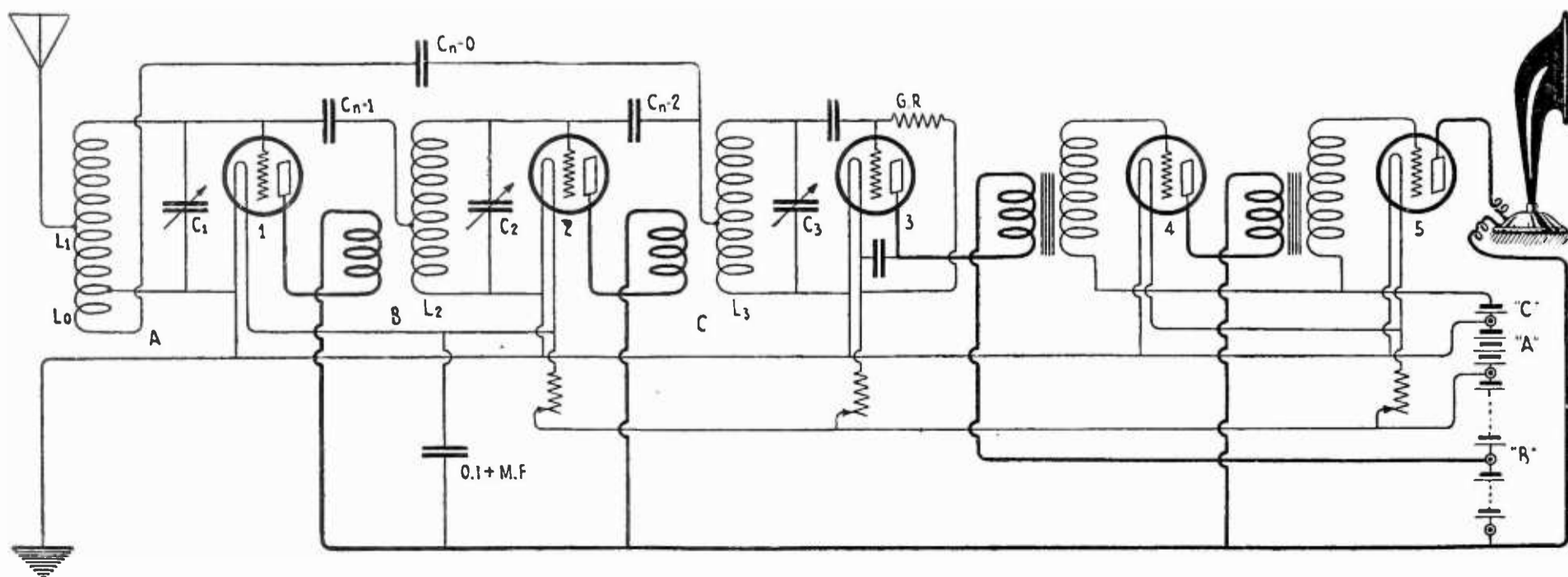

FIG. 2

Circuit of a five-tube Neutrodyne, showing the method of neutralizing the over-all capacity

all tubes lighted. At this time the receiver will probably oscillate. The filament of tube No. 1 is then extinguished, usually by placing a piece of paper under one of the filament prongs. The dials can then be retuned for maximum signal. This signal is present only because of the coupling between circuits A and B introduced by the grid-plate capacity in the tubes. If now the neutralizing condenser C_n is increased, the signal will grow weaker and weaker and finally will disappear entirely. If the capacity is still further increased, the signal will again become stronger. The circuit is then said to be over-neutralized. An over-neutralized receiver will oscillate when all tubes are operating.

If the tube capacity is exactly balanced while the filament is not lighted and still cold, no signal will be transmitted through the succeeding tubes. The explanation of this is as follows: Referring to Fig. 2, the voltage present in circuit A causes a current to flow through the grid-plate capacity of tube No. 1, but at the same time another current flows through the neutralizing condenser C_{n-1} . These currents in passing through the primary and tapped portion of the secondary of circuit B, respectively, produce equal and opposite magnetic fields in circuit B which cancel out and produce no resultant voltage.

A third neutralizing condenser is sometimes used for the purpose of neutralizing the very small capacity existing between circuits A and C. This will be discussed in detail later. It should be noted in Fig. 2 that primaries of the audio-frequency transformers are reversed relative to the secondaries in a manner similar to that employed in the radio-frequency circuits. This very often prevents "singing or howling" at audio frequency. It might even be worth while for the purpose of improving the quality of reproduction to completely neutralize the audio-frequency tube capacities. This could be done by the introduction of very small capacities between adjacent grids.

For Those Who Have Built Their Own and for Those Who Haven't

This paper on the Neutrodyne receiver will have an appeal. As Mr. Dreyer, who is an assistant to Professor Hazeltine, the inventor of the Neutrodyne, says, "In one short year the Neutrodyne has sprung into very great general popularity." The many owners and operators of Neutrodyne sets should read this with great interest because it treats of kinks of operation and experiment with this type of receiver which have not appeared anywhere else. Those who have heard a great deal about the receiver and are a bit hazy on just how it works can easily bolster up their weak technical points by reading this paper.—THE EDITOR

HOW TO PREVENT REGENERATION

IT IS necessary in a Neutrodyne more than merely to neutralize the tube capacities. In the conventional type which employs three sharply tuned circuits it is necessary to remove all couplings that may exist between these circuits except mutually conductive or one-way coupling of the tubes. In fact if in any way radio-frequency energy may be transferred from one circuit to a preceding one, regeneration will usually occur. This is always undesirable since it has the effect of sharpening the tuning to too great an extent and thus ruining the quality of reproduction. The capacity couplings due to the tubes may be neutralized by

the method already described. The other couplings which should be eliminated are:

(1) inductive coupling between adjacent stages (coils L_1-L_2 , L_2-L_3); (2) couplings from the second to the first stage due to the impedance of the leads to the B battery; (3) coupling from the third to the first and second stages due to improper connection of the telephone condenser; (4) coupling introduced by a common C battery or due to improper connection of grid returns; (5) coupling between stages introduced by inductive loops in the wiring; (6) coupling between first and last stages due to inherent capacity between high-potential surfaces of these stages.

The first of these, inductive coupling between coils of the different stages, may be eliminated by properly placing the coils. As is well

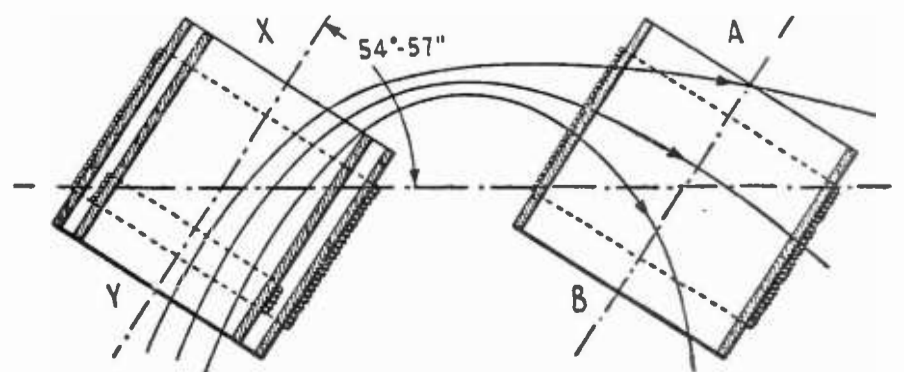

FIG. 3

How the angles of the coils used in the Neutrodyne receiver may be used to give zero magnetic coupling

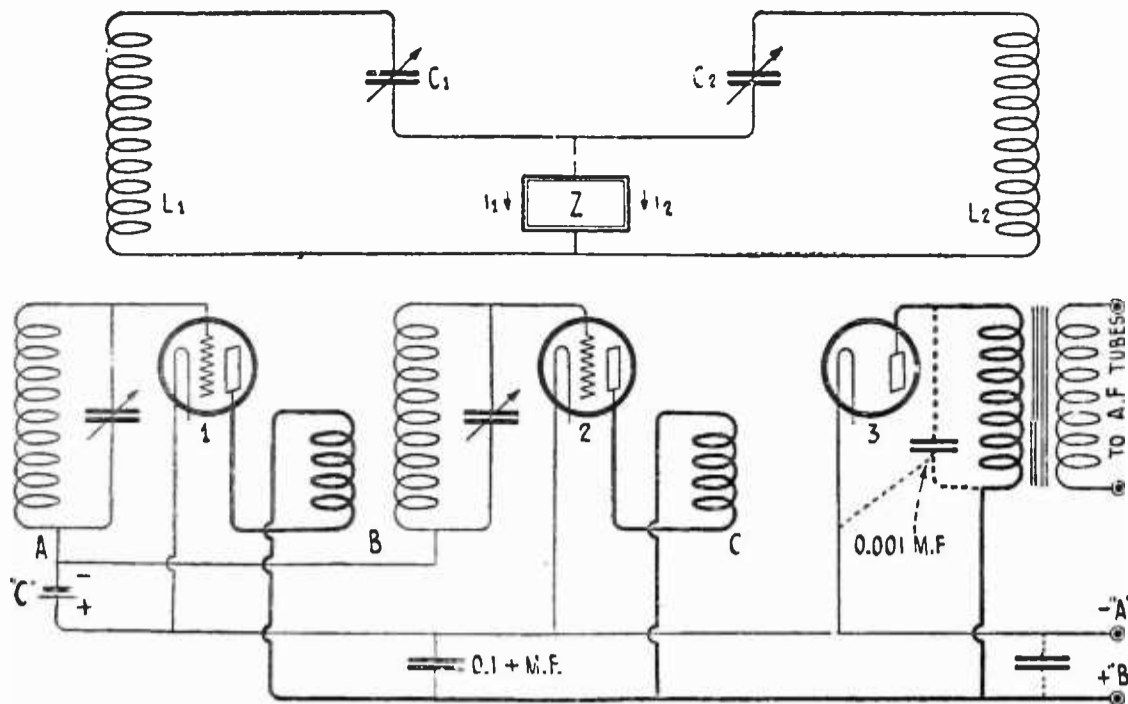

FIG. 4.

How coupling other than that due to tube capacity may be eliminated

known, three coils may be placed mutually at right angles, so that the magnetic flux of any one has no resultant linkage with the turns of the others. A neater and more symmetrical arrangement was devised by Professor Hazeltine. He discovered mathematically that any number of coils might be placed on a common line of centers and if their axes were inclined at an angle of 54.7 degrees to this line of centers, no magnetic coupling would exist. That this is physically possible is rather hard to visualize at first. In Fig. 3 two coils are shown inclined at the theoretically correct angle. Magnetic flux of coil XY will pass through coil AB roughly as shown. Some of this flux, as represented by the middle line, passes through coil AB in a direction perpendicular to the axis of that coil and therefore does not link with the turns at all. Other portions of this magnetic flux will link with turns on AB. Some of it passes up and some down through the coil. There are, therefore, flux linkage in both senses. It seems reasonable that if the coils are set at some such angle as this, zero coupling may be obtained. This is true, but the angle varies slightly from the theoretically correct one, due to conditions not being ideal. The most conspicuous reason for variation is the fact that the leads which carry the coil current to the condenser form a single turn in an entirely different plane from the turns on the coil itself. The exact angle may be determined in any given receiver whose coils are first set approximately correctly as follows: the neutralizing condensers are first adjusted for a high broadcast frequency in the manner previously described. The settings of the two neutralizing condensers C_{n-1} and C_{n-2} ,

Fig. 2, are then noted and the process repeated at a low broadcast frequency. The settings will be in general different. This is due to the fact that, if inductive coupling is present between adjacent coils, the neutralizing condenser counteracts this as well as the coupling due to the tube capacities. This neutralization will be exact for only one frequency, because with varying frequency the coupling effect due to the mutual inductance between coils varies at a different rate than the negative coupling effect due to the capacity C_n . If the settings are different, the coil angles are shifted a slight amount and the process repeated.

When the neutralization is correct at both high and low frequency ends of the scale, the coil angle is correct. It has been found to vary by this method from 54 to 58° in different receivers.

INTER-CIRCUIT COUPLING IS OBJECTIONABLE

OBJECTIONABLE coupling between circuits due to the use of a common C battery has proven very troublesome, but not unavoidable if proper precautions are taken. The coupling introduced by the battery is analogous to that introduced in the theoretical circuit shown at the top of Fig. 4 by the impedance Z. Here the current of circuit CL_1 flows through the impedance Z which is common to circuit C_2L_2 . It is evident that the current of one circuit will induce a voltage in the other, or it may be stated that if any portion of the current of one circuit flows through an impedance in common with any portion of the current of another, then these circuits will be coupled. The lower portion of Fig. 4 illustrates several ways in which this sort of coupling may be introduced (batteries, rheostats, and non-essential wiring are omitted to avoid confusing the figure) The plate circuits of tubes 1 and 2 carry radio-frequency currents which, like all other electric currents, must flow in closed paths. Let us trace the probable path of the radio-frequency current produced by tube No. 1. Starting at the plate it passes through the primary of unit B and thence to the B battery, through the battery, and back to the filament, where the electron stream completes the circuit to the plate. If it does take this path, the batteries and, more important, the leads to the batteries,

form an impedance through which a similar current from tube No. 2 must also flow. This common impedance introduces coupling. A large condenser placed as shown between the +B and the -A leads has the effect of by-passing these currents and preventing their passage along common leads. To be effective, this condenser should be of at least 0.1 microfarad capacity. Also it should be carefully placed at the point which provides the minimum of common wiring for the currents in the separate circuits. It would be less effective if placed at the right, as shown by the dotted connections.

The detector plate circuit also carries radio-frequency current for which a reasonably low impedance path must be provided. If this path is not provided the signal will be considerably weakened. In regenerative circuits it is common practice to shunt the high impedances of the telephones or audio-frequency transformers by a condenser of about 0.001 microfarad capacity. This must also be done in the Neutrodyne, but care must be taken to connect this condenser from the plate of the detector *directly to its filament*. Otherwise if connected as shown alternatively in Fig. 4, a large radio-frequency current must pass through the B battery in order to complete its circuit. This might readily cause trouble.

PREVENTING COUPLING PREVENTS OSCILLATION

COUPLING sufficient to cause oscillation has been found when either a C battery or a common filament rheostat has been used to introduce a negative bias on the grids of the radio-frequency tubes. (See Fig. 4.) This is analogous to the coupling introduced by the common B battery, since the currents which pass through the grid filament capacities for

the first two tubes must return to their starting points by way of this rheostat or C battery. If such a device is used, it should be by-passed with a large condenser which is located in the most desirable place, namely the one which provides the least common wiring for the different currents. It has not been found necessary to use a bias on the radio-frequency tubes and therefore the grid returns are usually connected directly to the negative filaments of the separate tubes as illustrated in Fig. 2.

Inductive loops in the low potential wiring cause a great deal of trouble and are present in a great many "home-made" receivers. If, for instance, the negative and positive battery leads are far apart, a loop closed at the ends by the filaments of the tubes is formed. This loop has mutual inductance to all coils in the receiver and provides a path for the feed-back of energy which is often sufficient to cause oscillation. The remedy for this is obvious and simple. All wires which carry the B or A battery currents should be bunched together and thus minimize the area of possible loops.

It was found in certain receivers that after all other possible sources of coupling had been eliminated that energy was fed back through the extremely small capacity usually present between circuits C and A. This capacity may be eliminated by shielding, but because this is expensive, several types of receivers have been equipped with a third arrangement which serves to neutralize this last form of coupling. The effect of this coupling capacity is only noticeable in receivers having very low resistance circuits and having therefore very high amplification. It is accentuated by the presence in the neighborhood of the receiver of a piece of ungrounded metal such as a long piano hinge on the cabinet. Also, if the antenna is connected

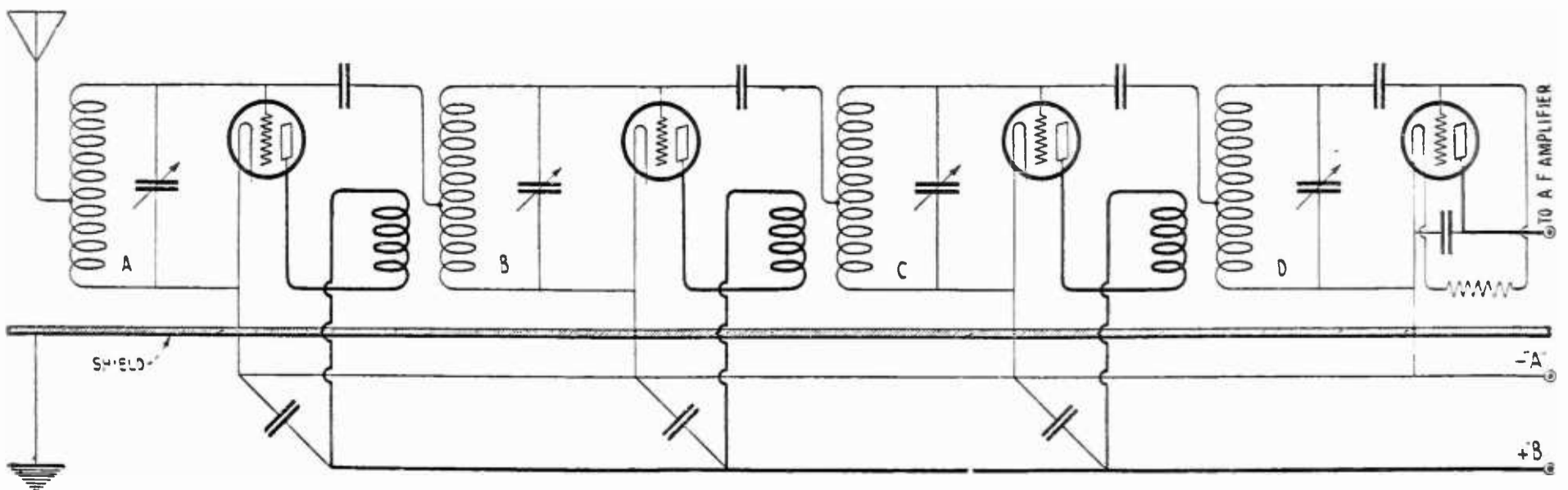

FIG. 5

How the "segregated shielding" is used in a three-stage (radio-frequency) Neutrodyne

in such a way that it passes behind the receiver close to the last circuit, the effective capacity between the first and last circuits is increased. The antenna lead may be shielded with a grounded metal tube or Belden braid, and the metal hinge may also be grounded. If these precautions fail to remove the trouble, complete shielding or neutralization must be resorted to. Neutralization of over-all capacity may be accomplished with the arrangement of Fig. 2 already referred to. When adjusted, the action is as follows: a very small current passes through the space from the high potential parts of circuit C to circuit A. However, another larger current flows through the third neutralizing condenser Cn-O. This current, in passing through the extra coil L_0 which is coupled closely to L_1 , produces a magnetic effect in circuit A exactly equal and opposite to that produced by the first current in flowing through

L_1 . The net regenerative effect is then zero. It is interesting to note the relative size of the coils and capacities involved in this action. In a certain receiver L_1 , L_2 , and L_3 are of 65 turns each. A tap on L_3 used for two neutralizing condensers is located 8 turns distant from the grounded side of that coil. L_0 has but one turn. The neutralizing condenser Cn-O is of the usual form and when adjusted has a capacity of about 10 micro-microfarads.

The adjustment of this third neutralizing condenser is accomplished by first encouraging the receiver to oscillate. This is done by tuning the circuits to the highest possible frequency and by adjusting the plate and filament voltages to produce the greatest amplification. If the receiver oscillates under these conditions, the condenser Cn-O is increased until oscillation ceases. If increased too far oscillation will again commence. The correct setting of this over-all condenser is, of course, at the center of the range of non-oscillation. If no oscillation or regeneration is noticeable when these steps are taken, over-all neutralization is unnecessary and may be omitted.

Another cause of unsatisfactory operation on the part of Neutrodyne receivers is that introduced by local conditions. High impedance ground leads may be the cause of oscillation for reasons which are not very clear. The trouble may usually be eliminated by replacing the long lead with a short one to the nearest piping system, such as the radiator or water pipe. If the A battery is located at some distance from the receiver and is wired to it with long leads, trouble again may occur. This form of oscillation trouble usually appears over only a limited frequency range and is probably due to an action which occurs at the natural period of the ground or battery system.

THREE-STAGE NEUTRODYNE RECEIVERS AND THEIR PROBLEMS

SO FAR, all discussion has been limited to the two-stage receiver. Successful three-stage Neutrodyne receivers have been constructed and when finally adjusted give very great amplification and selectivity. One of these constructed by H. W. Dreyer and the writer and used with a ten-foot indoor antenna compared favorably with the performance of a good two-stage receiver when used with an outdoor antenna 75 feet long.

The problems which arose in the construction of this receiver were of the same nature as

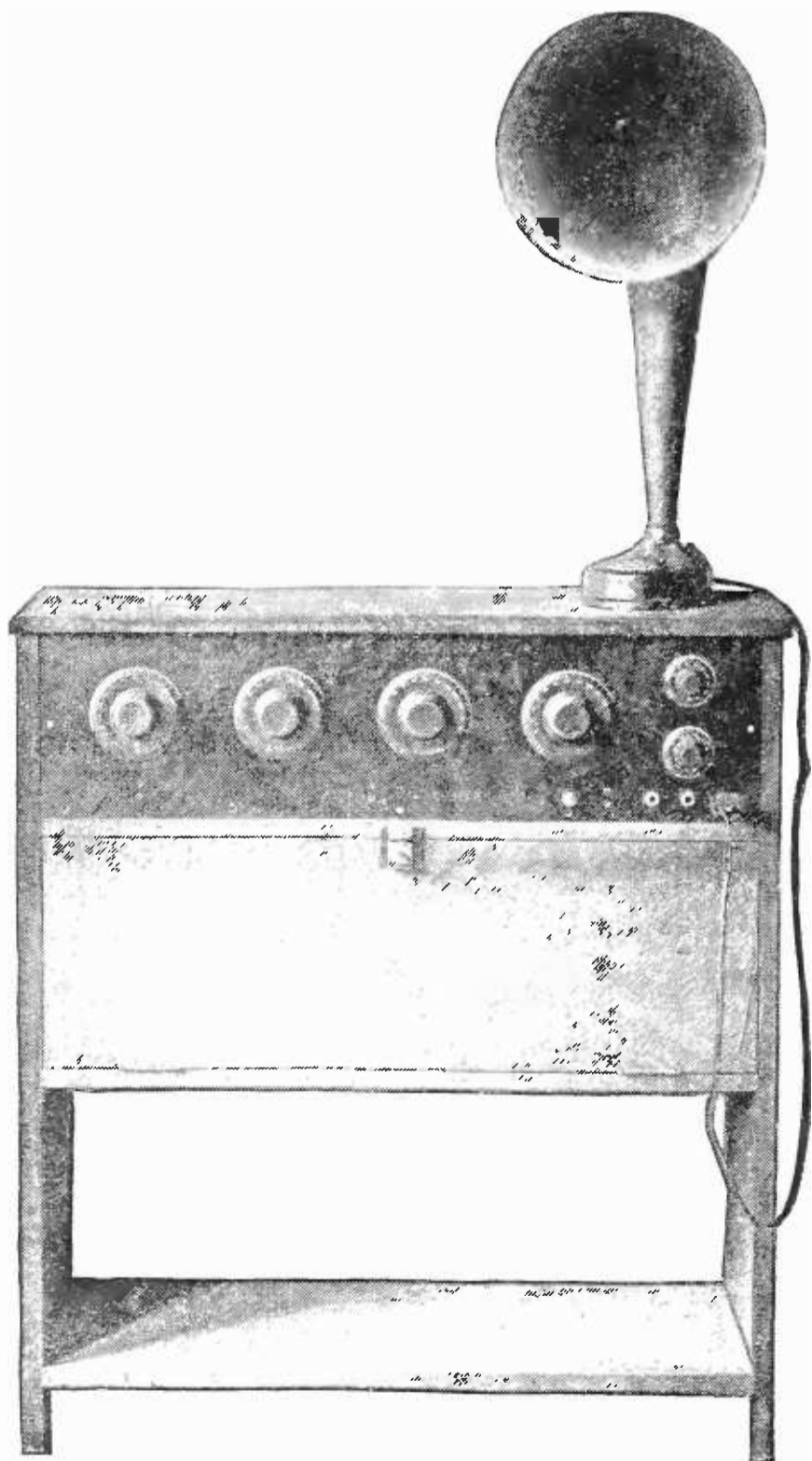

FIG. 6
An experimental three-stage Neutrodyne

those previously discussed. They are, however, more difficult to solve, and the stray coupling had to be eliminated to an even greater degree than was necessary with the two-stage. Fig. 5 illustrates schematically some of these problems.

It should be noted that three separate by-pass condensers are used to prevent B battery coupling. The most troublesome coupling, however, was found to be that due to over-all capacity. This becomes of more and more importance as the amplification increases. When four tuned circuits are used, it becomes too cumbersome to effect a neutralization of all capacity couplings between circuits. Since to eliminate them would require six adjustments, it was decided to shield out as much as possible of these capacities and neutralize the remaining tube capacity by the Hazeltine method. The shielding of a copper lined cabinet proved ineffective, due probably to eddy currents set up in the shield. These currents caused coupling between first and last stages in a manner similar to that caused by inductive loops in the wiring.

Shielding in the form of a cabinet lined with copper wire grids did prove effective. Care was taken to see that no closed loops were formed

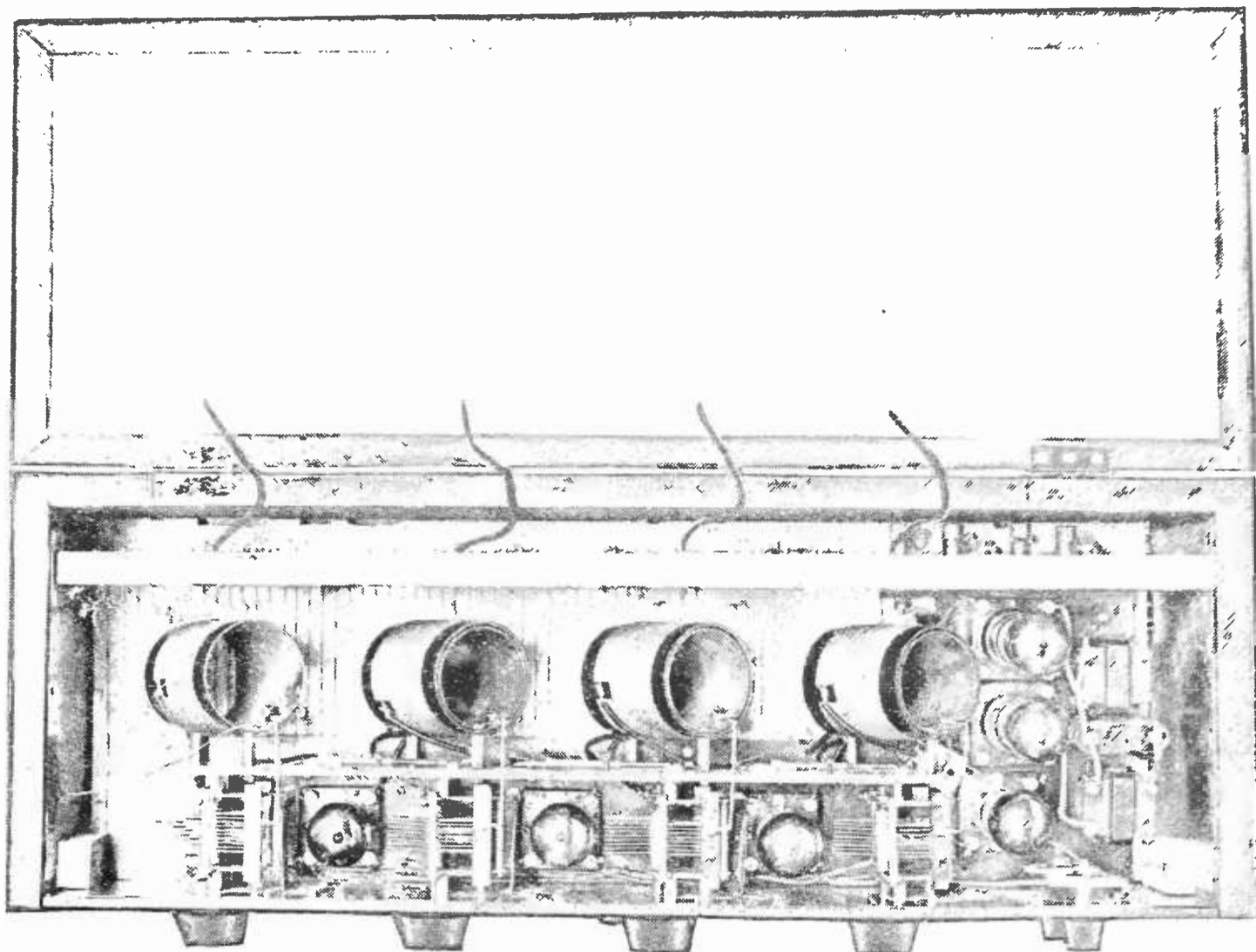

FIG. 7

Top view of a three-stage (radio-frequency) Neutrodyne. Note the wire shielding in the bottom of the cabinet

in this shielding. Also it was necessary to segregate it into four insulated portions adjacent to the four coil systems. These four sections were grounded at the low-potential points of the individual coil systems. Of course, no attempt was made to shield the magnetic fields, but these are not harmful if the coils are at the proper angle.

In the short year that the Neutrodyne circuit has been before the public it has met with very great popular approval. In the coming year improvements will undoubtedly be made, but probably not of a radical nature. Greater amplification may be expected by more careful construction and by the use of more shielding.

A. J. HAYNES has written an interesting and informative article about the super-heterodyne and why high frequencies should be used in the intermediate-frequency amplifier, a subject which has received very little attention. The article will help any experimenter who is building a super-heterodyne and will aid and interest those who already own a receiver of this type; it will be printed in an early number.

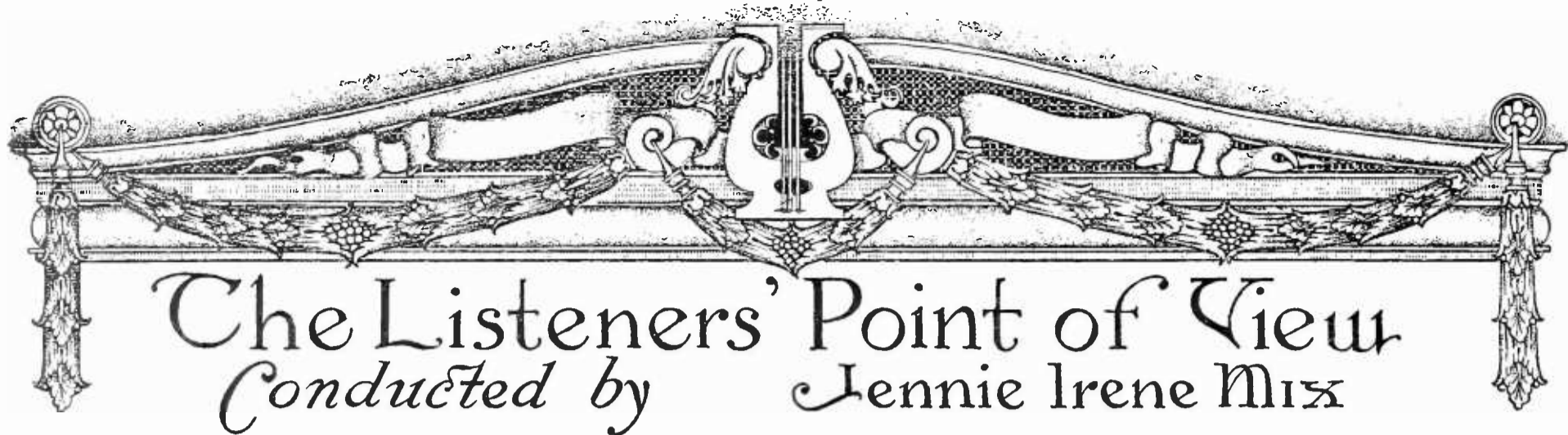

The Listeners' Point of View

Conducted by Jennie Irene Mix

Are Women Undesirable—Over the Radio?

AFTER having written for the June number of this department a nice little comment regarding women announcers, and one such announcer in particular, came the discovery, when this same number was published, of a letter in the department, "What Our Readers Write Us," denouncing all women announcers because, the voice of a woman when she cannot be seen "is very undesirable, and to many, both men and women, displeasing."

The man responsible for this opinion bases it on his experience with the sales of phonograph records. Various manufacturers lost several thousands of dollars, he tells us, before they learned that the public will not pay money to listen to the talking record of a woman's voice.

This is interesting. And when one stops to consider the matter it is impossible to recall a phonograph record of a monologue by a woman. Yet some of the highest paid women in vaudeville are the women heard only in monologues.

Does this mean that when a woman is speaking she may be fascinating as long as she remains in sight, and becomes displeasing the moment she cannot be seen although she may go right on talking just as delightfully as the moment before? That is exactly what it means provided the experience of the phonograph men is all the evidence needed to prove so radical a statement. But is it logical to draw final conclusions regarding so important a matter from but one medium of experiment? It scarcely seems so.

In its fundamentals the question is one for the psychologists to deal with. Perhaps, now that the radio is bringing women daily before the microphone, psychologists will delve into this subject and, if their conclusions agree with

that of the phonograph dealers, we shall then know the cause for this strange difference in the effect produced—in the opinion of some—between the voices of men and women when the speakers are invisible.

It would be interesting to know how the radio public feels about this matter. Let us, for instance, take station WOR at Newark. Many women speakers have been presented from this station, women of notable achievement in various avenues of activity, with the majority drawn from the dramatic profession.

Surely, if a woman's voice is both displeasing and undesirable over the microphone, WOR must have received complaints along this line from many of those who regularly tune-in on this station. Any report from there would be something of a test because no other station in the country has presented so many women in speeches and monologues as has WOR.

Then there is WGY at Schenectady, where scarcely a week passes without the presentation of a radio drama with women in the cast. Do the unseen audiences experience a feeling of repulsion every time Rosaline Greene or Lola Summers, Marie Prott, Charlotte Paulos, Mildred Stanyon, Gemma Votties, or others among the women in this dramatic company, speak? If this were true, then WGY would have received so many objections to presenting women before the microphone that plays employing both men and women would long since have been discontinued. Which would mean the discontinuance of all their drama programs, for no one of any sensibility could listen to a radio play given entirely by men.

We are willing to grant that were the profession of broadcast announcing to be equally divided between men and women the honors would without question go to the men. But this



ETHYL HAYDEN

This young lyric soprano, favorite among large numbers of concertgoers, recently gave pleasure to many thousands of unseen listeners when she sang the rôle of Marguerite in the concert performance of "Faust," given at Mankato, Minn., and broadcast through WLAG

does not prove that all men are successful as announcers and all women unsuccessful.

Women, as a rule, when they speak over the microphone, are apt to make one of two mistakes. They either speak in a patronizing tone or they are precise to a point of exasperation. With the latter, it is as if they stopped to cross every T and dot every I. The effect in either case is disagreeable. And, so far as the present writer's experience goes, women radio speakers are lacking in humor. On the other hand, men are inclined to be preachy. Here is a choice of two evils, one as bad as the other. But there are some men heard via radio to whom it is joy unalloyed to listen.

There are a few announcers in this country—all men—who are beyond criticism. They are consequently an unending pleasure to hear, from their first greeting to their final, "good night." They know just how far to carry familiarity in their speech—a trait that is the

final test of an announcer's adaptability to his position. The men who are continually "jolly-ing" their listeners, trying themselves to be entertainers, become extremely tiresome. A little of this sort of thing may be agreeable and effective, but more than a little becomes a surfeit. This is not an individual opinion, but one that has been expressed by large numbers of people.

If Mr. Henry Ford ever loses his job as a maker of automobiles he could undoubtedly get a position as announcer without half trying. This was proved when, at the close of the recent automobile race at Indianapolis, he was lured to the microphone by the genial Mr. Kaney who, for five hours, had himself been at the microphone announcing the progress of the race which was broadcast by WDAP and WGN, Chicago.

Although Mr. Ford had been busy for many hours in his capacity as referee, his voice came through the air as fresh and vigorous as if



—Apeda, New York

PAUL SPECHT'S FAMOUS ALAMAC ORCHESTRA

Just as you sometimes "cannot see the forest for the trees," so you sometimes cannot see a jazz orchestra for the instruments. There are eleven men in this Alamac orchestra, and, without including those manipulated by the man at the drum, there are about two dozen instruments in the picture. To the drummer can easily be credited half a dozen more. An average of three instruments, let us say, to a man. But while some are accountable for only one instrument, others handle two—three—four—or five. Yet when you hear them via radio, which it is your privilege to do twice a week through station W J Z, the orchestra plays with a smoothness which gives no indication that any of the men change from one instrument to another during a performance

fatigue were something unknown to him. It was a perfectly poised, finely modulated, clear cut voice that would have held the attention even had the speaker been unknown. And Mr. Ford said in a few seconds as much as some radio speakers would have taken five minutes to say, and without saying it as well, at that.

But, according to our phonograph authority, if the most famous woman living had been at that race and had been persuaded by Mr. Kaney to speak over the microphone, all who heard her would have found the experience displeasing.

How do you feel about this question, my readers?

Program Director—Musician—Woman

WHATEVER may be said as a generalization regarding women announcers, Mrs. Eleanor Poehler, director and chief announcer at station WLAG, has been sufficiently successful in her work to bring her many assurances of commendation from radio fans, near and far.

Mrs. Poehler is a musician of broad education and experience. Left a widow a year after her marriage, she turned her attention to the cultivation of her voice, having the good fortune to study with the internationally known teacher, Mme. Schoen-Rene, who was then a resident of Minneapolis. There followed a period of study in Europe. Upon her return to this country Mrs. Poehler was occupied with concertizing and teaching. Then came another period of study abroad, this time chiefly in England. The breaking out of the War forced a return home.

"I have carried on ever since," said Mrs. Poehler when asked to tell further details of her career. "When the position of program director at WLAG was offered me, I was given but twelve hours to reach a decision. I have been glad ever since that I had so little time to consider the matter, because I took a flying leap in the dark and have loved the work better than anything else I have ever done. I am still singing and expect to continue doing so for a number of years to come. I have lost my fairness, am trying to keep away from fatness, but cannot possibly avoid fortyness."

Mrs. Poehler has for many years taken active interest in musical educational work in Minnesota and the Dakotas. It was she who first made a special study of radio voices, and



—Mishkin, New York

FREDA BENNECHE

Born in New York, the daughter of Edward Benneche who, for years, was president of the Arion Society and prominent in other musical circles, Miss Benneche, coloratura soprano, came naturally by her musical gifts. She was recently heard by radio through station WOR

through tests proved that many voices of good quality that are too small of volume for the public concert stage, are admirably adapted for radio performance because of the increased volume made possible through amplification. She has created several popular radio stars in the Northwest since she took over WLAG. Any one listening in regularly to her programs can readily see that she is not carrying on her radio work simply for the purpose of "giving the public what it wants," but rather with the idea of affording the radio public opportunities to hear a sufficient amount of good music to gratify those who already appreciate it, and to create a taste for it among those who, hitherto, have listened to little but trash.

Good Programs from Here and There

THE last concert for the season given by the Mendelssohn Glee Club of Albany, with Mary Jordan, contralto, as assisting soloist, and broadcast through station WGY,



© Underwood & Underwood

WILLIAM VAN HOOGSTRATEN

Joint conductor with Willem Mengelberg of the New York Philharmonic orchestra which was frequently heard by radio audiences during the last season through station W E A F. Mr. Hoogstraten is this summer chief conductor of the concerts being given by the Philharmonic orchestra every night at the Lewisohn Stadium, the College of the City of New York

provided an agreeable evening for listeners-in. The Russel Sage College Glee Club heard through WHAZ was another excellent feature. The Girls' Glee Club of the Davenport, Iowa, High Schools and the combined quartets from the Junior High Schools of the same city were enjoyed through WOC. And the Advanced Elementary School Orchestras of St. Louis, heard through KSD, gave a public concert sufficiently well-done to hold the attention throughout the entire performance.

A Radio Singer Advances

HERE'S wishing Miss O'Brien of Kansas City the best of success in her future musical work!

Miss O'Brien, who has a brilliant full soprano voice, far superior to the majority of voices heard over the radio, has frequently sung at station WHB, Kansas City. Not long ago she gave her farewell program preceded by the announcement that she was going East to study

with the view of furthering her career. Her singing seems to justify her ambition to develop her work to the fullest possible extent. Every venture to become a widely known professional in the musical world these days when competition is so keen, is a big risk, and that is why one admires those who make the venture when, as in the case of this young soprano heard by radio, there is sufficient natural gift to justify ambition.

So—again—here's wishing Miss O'Brien of Kansas City the best of success!

What Are the Elite Radio Orchestras?

HOW many orchestras heard regularly over the radio make it a custom to give occasional programs composed wholly of standard musical works? By standard musical works is meant works that have been accepted by the musical world as worthy of performance on orchestral programs constantly given through the regular concert channels. This eliminates all jazz and the ephemeral popular music that is here to-day and gone to-morrow.

Note that the question is not how many orchestras heard over the radio always give



—Zintsmaster, Minneapolis

MRS. ELEANOR POEHLER

Director and Chief Announcer of station W L A G, St. Paul—Minneapolis

programs of standard works, but—how many even occasionally give such programs?

The conductor of this department greatly desires full statistics regarding this matter. She at present has but a very small number of such orchestras on her list.

Who will help make this list complete by sending in the name or names of any radio orchestras known to be in this class? Individual credit for all such information will be duly given in this department.

The Girl Scouts at Chicago

ALTHOUGH it is not unusual for some broadcast stations to put on programs given wholly by girl scouts, the first time, so far as can be learned, that the camp song, "Innisfree," was heard by radio was during the recent annual National Convention of Girl Scouts held at Chicago when this song, which was the official song of the convention, was broadcast from station WDAP, now WGN. The singer was Elsa Clement, Field Captain and Captain of Troop 26, Toledo Girl Scouts.

From reports that came in later, girl scouts all over the country listened with delight to this song which they all love, although it is far from being either ragtime or jazztime. The poem by William B. Yeats has become a classic while he is still living. It was set to music by an Englishman and is the official song of the English Girl Guides. Do you recall the poem? It begins:

I will arise and go now
And go to Innisfree
And a small cabin build there
Of clay and wattles made.
Nine bean rows will I have there
A hive for the honey bee
And live alone in the bee-loud glade.

And the last stanza, what an appeal it makes to many city-bound folks at this time of year!

I will arise and go now
For always, night and day,
I hear lake water lapping
With low sounds by the shore.
While I stand on the roadway
Or on the pavements gray,
I hear it in the deep heart's core.

A mile distant from Camp Andree Clark, Briarcliff Manor, N. Y., the largest national girl scouts' camp in the country, there is a log cabin where different groups of girls are sent, from time to time, to live the primitive life, without even cooking utensils or beds, being dependent wholly on their own efforts to get along. It is called "Innisfree," and the girls not only enjoy the cabin and seek the privilege of staying there, but they like its name because they like the poem and song.

Such is the romantic atmosphere surrounding the song that went out over the air to thousands of listeners from station WDAP in the great city of Chicago where the atmosphere is so alien to that pictured in "Innisfree."



—Livingston

ELSA CLEMENT

Who, during the National Convention of Girl Scouts in Chicago, broadcast the official song of the convention from station WDAP (now WGN)

Good Radio Music from Mankato, Minn.

NOT long ago, upon tuning-in this station, WLAG, came the announcement that a concert performance of "Faust" was about to be broadcast from Mankato, Minn. That settled it, so far as one listener was concerned. The evening would be spent enjoying this performance. The fact that it was given at Mankato meant that it would be well worth the hearing. For Mankato is one of the most musical towns in the entire country, a place where every artist, even the greatest, is happy to get a chance to appear. At the end of each season Mankato can show you a list of musical attractions presented that would make a similar list in many a good sized city seem indifferent in both quantity and quality.

During that performance of "Faust" there came to the listener, many hundreds of miles distant, a voice singing the rôle of Marguerite that held the attention throughout the evening, a voice of lovely quality and used with skill. It was later learned that the singer was no other than Ethyl Hayden, one of the foremost among the young lyric sopranos of the day.

When the radio can carry a voice many hundreds of miles with such fidelity that its quality and manner of production are unmistakable, it is a wonder that any manager stands in his own light by not permitting his artists to be heard, occasionally at least, through this medium. Hearing that singing by Ethyl Hayden was more convincing as proof of the quality of her work than would have been the perusal of a whole book of press notices about her.

Others in this cast who were heard to excellent advantage were Agnes Snyder in the doublerôle of Siebel and Martha; Louis Klebba as Faust; Rollin Pease, Mephistopheles, and Glen Shoemaker as Valentine. The choruses were carried off with telling effect by the Women's Glee Club and the Orpheus Club of Mankato, while the orchestra was a combination of the Mankato Festival orchestra and members of the Minneapolis Symphony. The entire production was directed by Mrs. H. A. Patterson with a vitality and flexibility that aroused unstinted admiration.

This performance was part of a spring festival

given at Mankato, and to WLAG should go a vote of appreciation from radio fans for making possible an opportunity to hear it.

Excellent Polish National Music from WGY

IT WILL be a long time before some of us who heard it, will forget the singing of Chopin's "Hymn to Polish Song," by the two Polish societies, the Kalina Glee Club and the Liberty Bell Chorus of Amsterdam, N. Y., and broadcast from Station WGY at Schenectady. It brought to a close a program composed, with but one or two exceptions, of Polish music sung by Polish singers in the vernacular. The way in which they interpreted this music was proof that, no matter how long they may have lived in this country, even if born here, the spirit of the land of their fathers animates them.

The fact that the program was not interrupted by a speech totally foreign to the subject of music added immeasurably to its enjoyment. Abominable custom—that of injecting speeches into the programs of radio concerts!



—White, New York

WADE HINSHAW

This is the man who led the "Radio Sing" at station WJZ. He was not so very long ago a grand opera singer, but during the last few seasons he has devoted his time to presenting the classic comedies of Mozart in tabloid form throughout the country with great success. Mr. Hinshaw's achievements in this line have done much to further the cause of Mozart among many who hitherto seldom had an opportunity to hear operatic music

MANY interesting talks are heard over the radio, but more often they are only partially heard, because they are almost always too long. Many listeners tune-out before the end is reached. When it seems as if the talk had continued for at least half an hour, the watch will show that it has been going on but fifteen minutes. Which proves that it should have stopped at the end of ten minutes.



HOW TO REBUILD A RADAK C-3 INTO A REFLEX RECEIVER

FIGURES 1, 2, 3, and 4 tell the story of how the Radak and similar regenerative receivers can be made over into a more efficient and desirable reflex set plus one stage of external audio amplification. The Radak C-3 is a single-circuit receiver manufactured by the Clapp-Eastham Company, designed to cover wavelengths between two hundred and two thousand meters, and includes a two step audio-frequency amplifier. It is an excellent receiver of its type. Radio progress and the appreciation of the interference caused by single-circuit regenerators have relegated it with antiquated and ostracized apparatus.

The Radak C-3 (as well as other receivers of this type but of different manufacture) are mechanically characterized by three predominant parts, a tuning coil, a rotating tickler and a variable condenser (plus, of course, two stages of audio-amplification). In the case of the Radak, there are two variable condensers, one for short waves and one for long waves. Single-circuit receivers, and how to recognize them, have been discussed at greater length in "The Truth About Trick Circuits" appearing in the March, 1924, issue of RADIO BROADCAST.

Sets of this type can be salvaged and made over into very efficient non-radiating reflex receivers at a cost that is nominal compared with the expense of totally new equipment.

THE ADDITIONAL PARTS

THE following extras are required for the reconstruction of the Radak and similar receivers:

Radio-Frequency Transformers, T ₁ and T ₂ , at \$3.00	\$6.00
One variable condenser, .00035 mfd. (17 plate)	4.00
One Celerundum Crystal Detector	1.25

Full details concerning the various possibilities for the radio transformers T₁ and T₂ will be found in "The R. B. Lab" for the current and last three issues of RADIO BROADCAST, as well as in articles, "A Knock-Out One-Tube Receiver" and a "Knock-Out Four-Tube Receiver" appearing respectively in the April and June numbers.

PREPARING THE RADAK

THE first step in this rejuvenation is the dismantling of the tuning inductance, fixed condensers, and the complete unwiring of the tuning elements.

What the Lab Offers You This Month

- How to rebuild your single-circuit Radak receiver into a reflex set.
- Variations in building the "Knock-Out" four-tube receiver, using Sickles coils for the inductances and Daven resistors.
- Some recommended resistances for use in resistance-coupled audio amplifier circuits.
- Installing a reconnected A battery rectifier for charging B batteries.
- How to make very efficient home-made inductances.
- Suggestions for adding to the home laboratory.

All connections are removed from the detector jack, and likewise from the binding-posts excepting plus B and plus and minus A. The first amplifying transformer is completely disconnected and the four leads permitted to hang freely.

The grid and plate connections to tube number two are removed, as well as the connection to the prong marked A of the middle jack (the left hand jack in Fig. 1). The original detector socket and detector jack are not used on the finished reflex set, tube number one being plugged in the middle socket and controlled by the middle jack (originally the first step jack).

The tuning coil is removed by unscrewing the two screws above and below the tickler dial, and the set screw on the shaft *behind* the panel. Clip the leads to the taps close to the panel. The circular fixed condenser is also demounted by removing the holding screws through the panel, which, on rebuilding the set, are used to hold the celerundum fixed crystal detector.

The front of the panel is left unaltered, the vernier dials and all controls, excepting the inductance switch and the detector rheostat, being used in the reconstructed receiver.

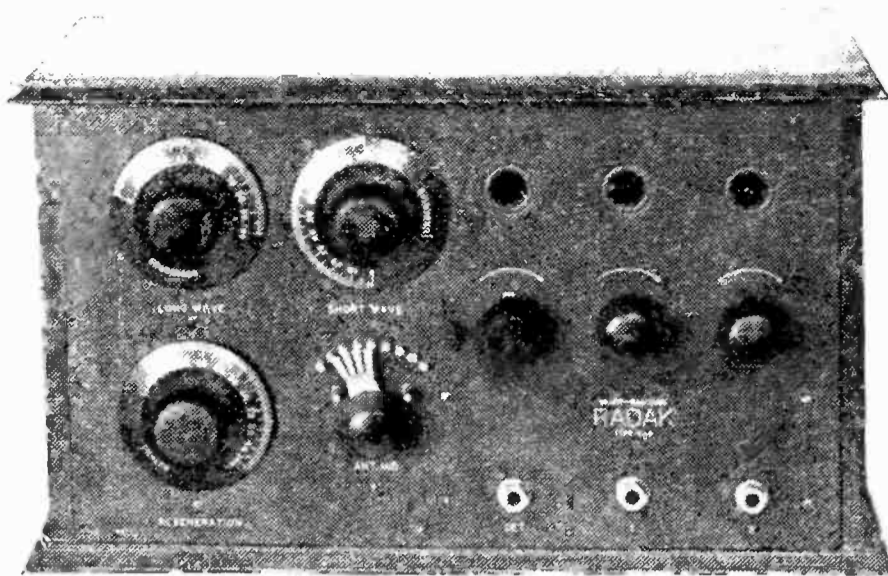

FIG. 2

The Radak C-3. All controls excepting the inductance switch, the detector jack and the detector rheostat are used in the completed reflex

REBUILDING

THE first task in reconstructing is to mount condenser C_1 and transformer T_1 in place of the dethroned tickler and tuner. As the vernier dial is fitted for an eighth inch shaft, it will be necessary to file or turn down the usual one quarter inch shaft on the condenser. This is easily accomplished using a flat file with the aid of a vise. File the shaft square, then hexagonal and finally round. This will

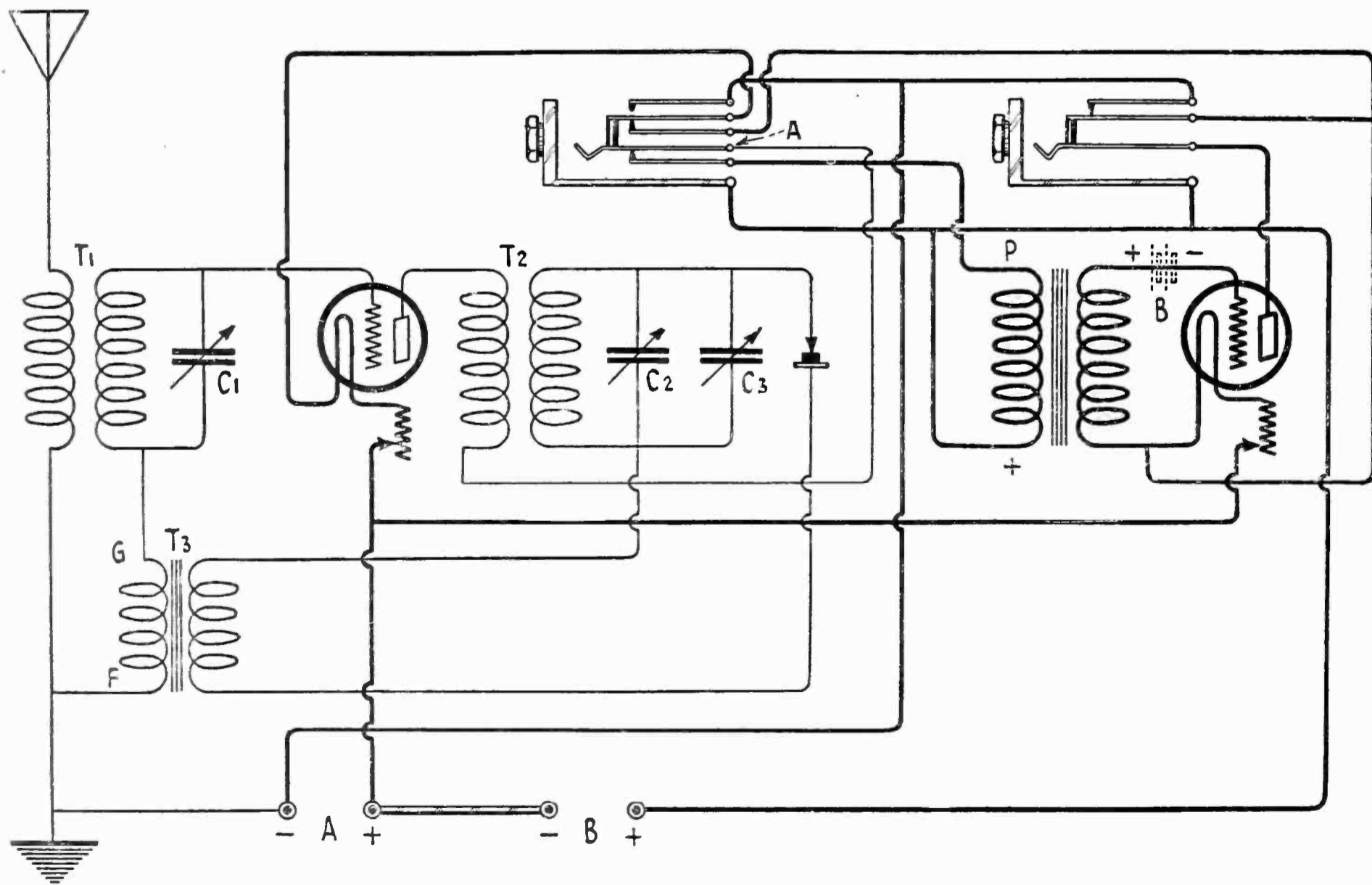

FIG. 1

The circuit for the rebuilt Radak. The reflex is a great improvement over the former single-circuit regenerator

generally achieve the desired reduction. It is probable that the shaft will also have to be shortened by about three quarters of an inch.

The condenser is then mounted on a $4\frac{1}{4}$ " by 3" piece of $\frac{3}{8}$ " wood by means of the usual screws. A $\frac{3}{4}$ " hole should be allowed for the shaft, through which the collar of the knob and dial may pass. A half inch slot is sawed from the outer edge to the center hole to permit the entrance of a screw-driver for tightening the set-screw. The condenser may now be mounted by means of the original screws passing through the panel, and T1 fastened to it with brackets. Fig. 3 illustrates this arrangement very clearly.

T2 is mounted on the small condenser, marked "low wave," which capacity is shunted, as a vernier, across the large 43 plate affair, C2.

The crystal detector is secured to the panel, as before mentioned, by means of the screws which originally provided the terminals to the circular fixed condenser. The middle screw is brought through the panel and tightened "blind" merely to hide the hole.

HOOKING UP THE "NEW" SET

THE circuit is shown in Fig. 1, and our old readers will recognize it as the justly famous single-tube reflex receiver plus one stage of external audio-frequency amplification.

Only two points in the wiring should bother the experimenter—the connections to the first amplifying transformer, T3, and those to the

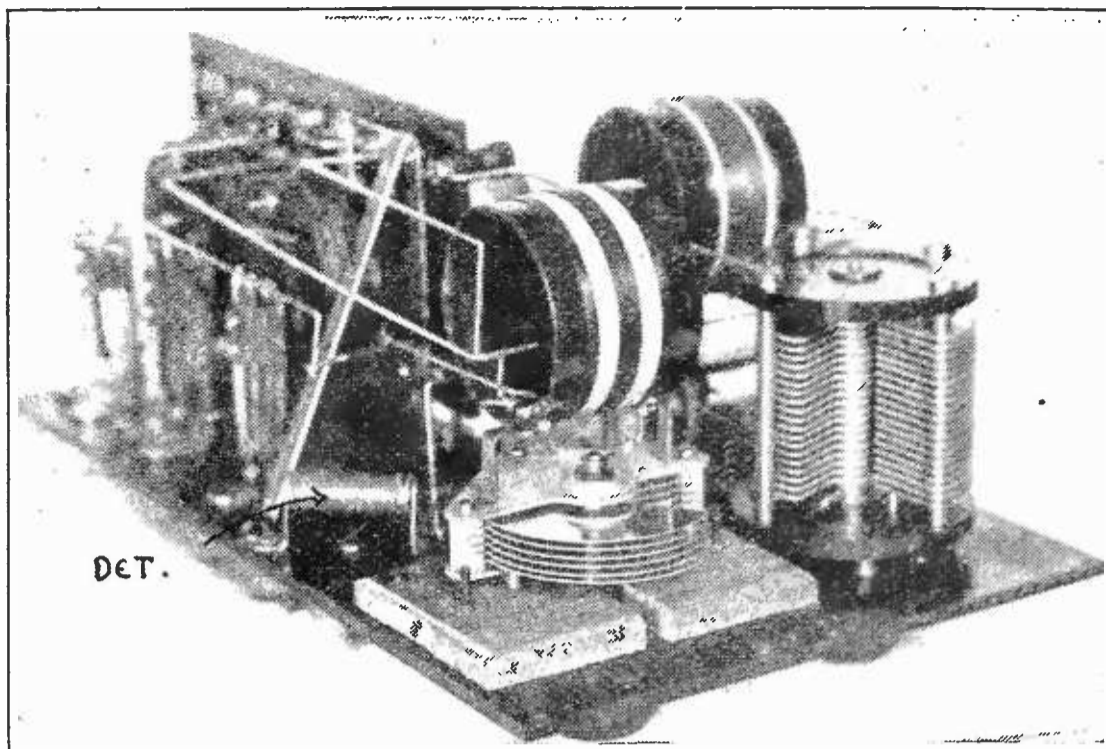

FIG. 3

Mounting the detector and condenser C1 without boring new holes

external amplifier. Even these obstacles are more imaginary than real.

If the secondary leads from T3 are examined, one will be found on the surface of the winding and the other a half inch or so nearer to the core. The inner wire is the filament connection (F) and the outer should be led to the grid (G).

To complete the plate circuit to the first tube, it is merely necessary to run the plate to the primary of T2, and from T2 to point A of the middle jack. The plus B battery is already wired from the binding-post to the jack, as well as are the filament connections for automatic control.

OPERATION

THE operation of the completed receiver is quite simple, and is that happy characteristic of the single-tube reflex. Almost all tuning is accomplished with C1 (the lower left dial), and C2 merely used to increase selectivity. The vernier, C3 will rarely if ever be touched.

As there is no bias whatever on the amplifying tube, such as is generally secured across a rheostat in the negative filament lead, it is probable that the amplifier will distort appreciably. This may be remedied by including a bias (C) battery, of three to six volts, in the grid circuit, negative to the grid. In the receiver described, the C battery is most conveniently placed as suggested by the dotted lines at B.

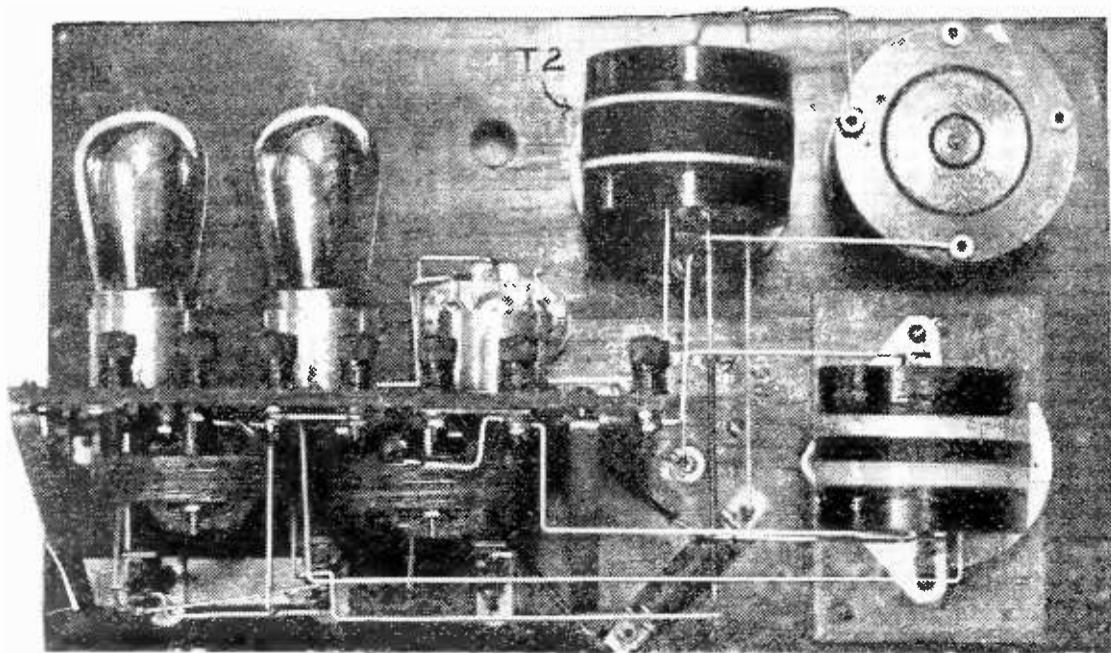

FIG. 4

Rear view of the rebuilt Radak. The detector jack, rheostat, and socket are not used

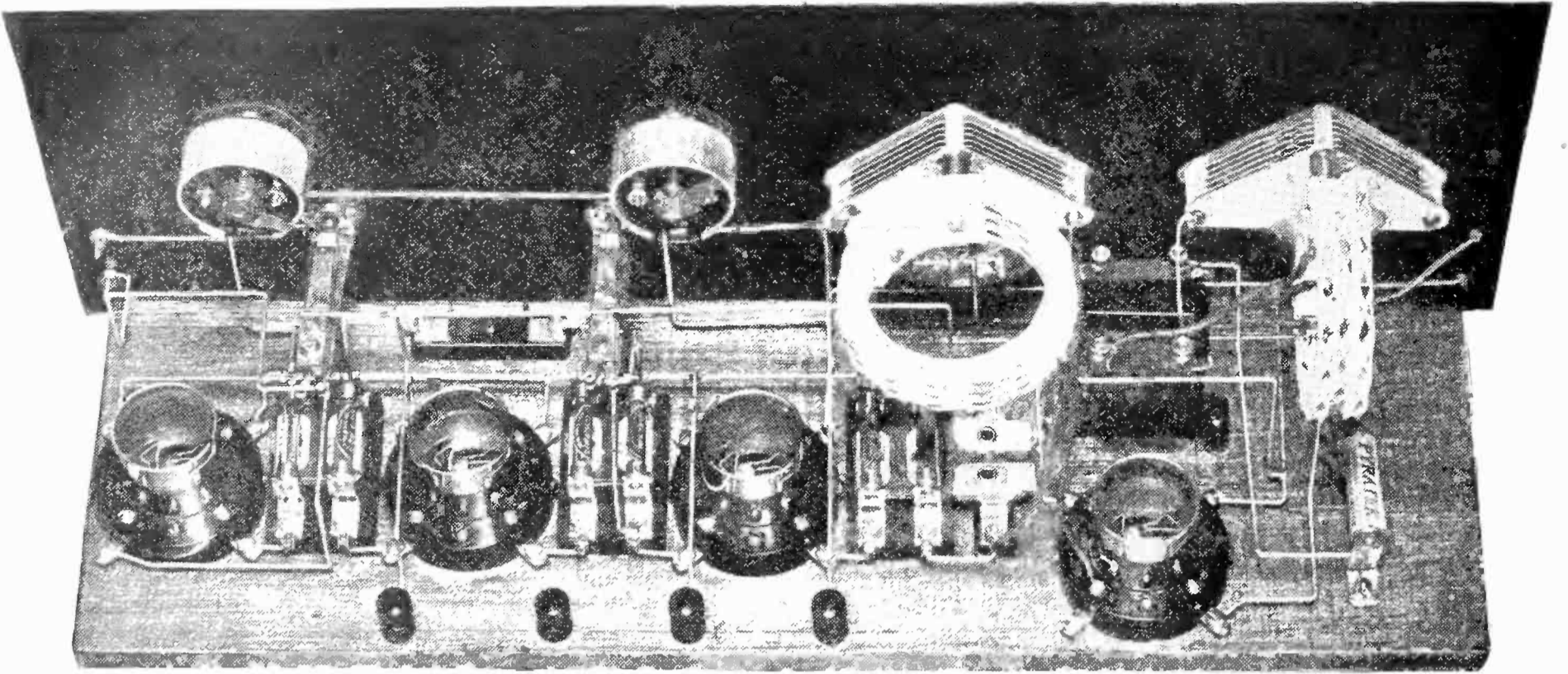

FIG. 5

Behind the scenes. Reflex and three stages of resistance-coupled amplification. The compactness and neatness are facilitated by the "Resisto-Couplers" between the sockets

The rebuilt Radak will give excellent loudspeaker volume on all local and many distant stations. The single tube alone will actuate the loudspeaker on locals. The set is quite selective, does not radiate or oscillate, and is very stable and easily operated.

ANOTHER FOUR-TUBE KNOCK-OUT

A SUBSEQUENT model of the receiver described by Zeh Bouck in the June RADIO BROADCAST is shown in photograph 5. This later design differs in several

ways from the original receiver, and represents improvements that will appeal to our many readers who have followed the "knock-out" series.

The panel layout has been altered slightly, the rheostats being raised one inch above the center of the panel. This balances the arrangement, and adds subtly to the aristocratic simplicity of the receiver.

The Sickles "Diamond Weave Transformer Coils" have been substituted for the rewind neutroformer type inductances. The Sickles coils are easily mounted on any type variable

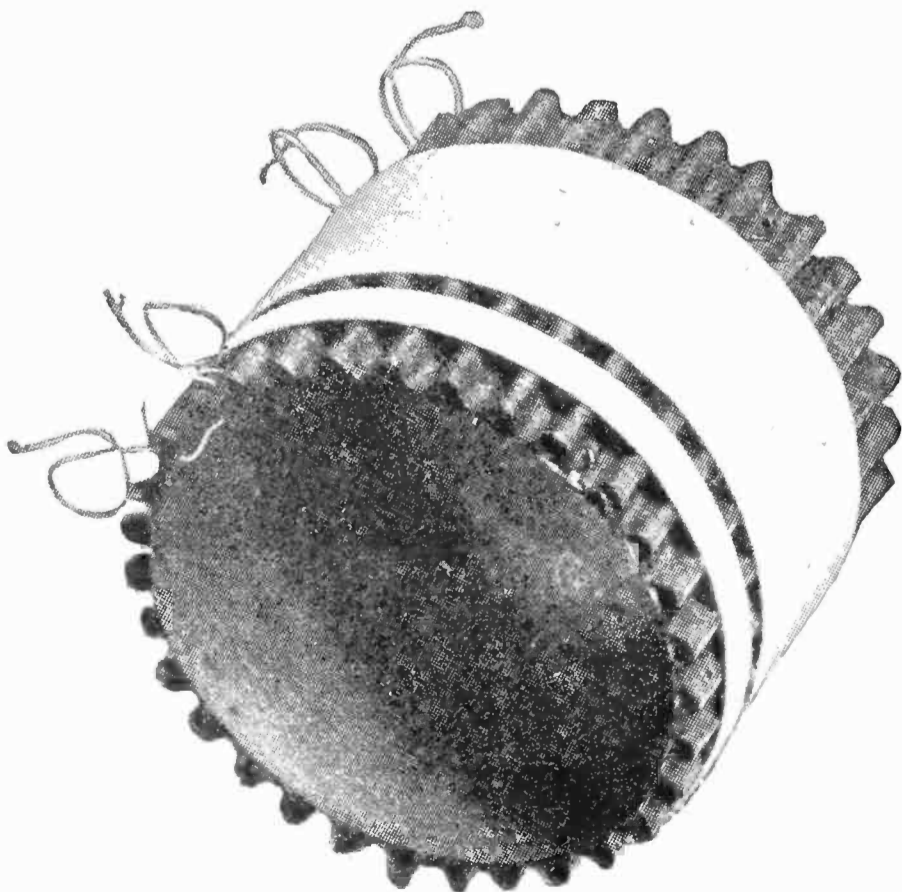

FIG. 7

A highly efficient form of inductance

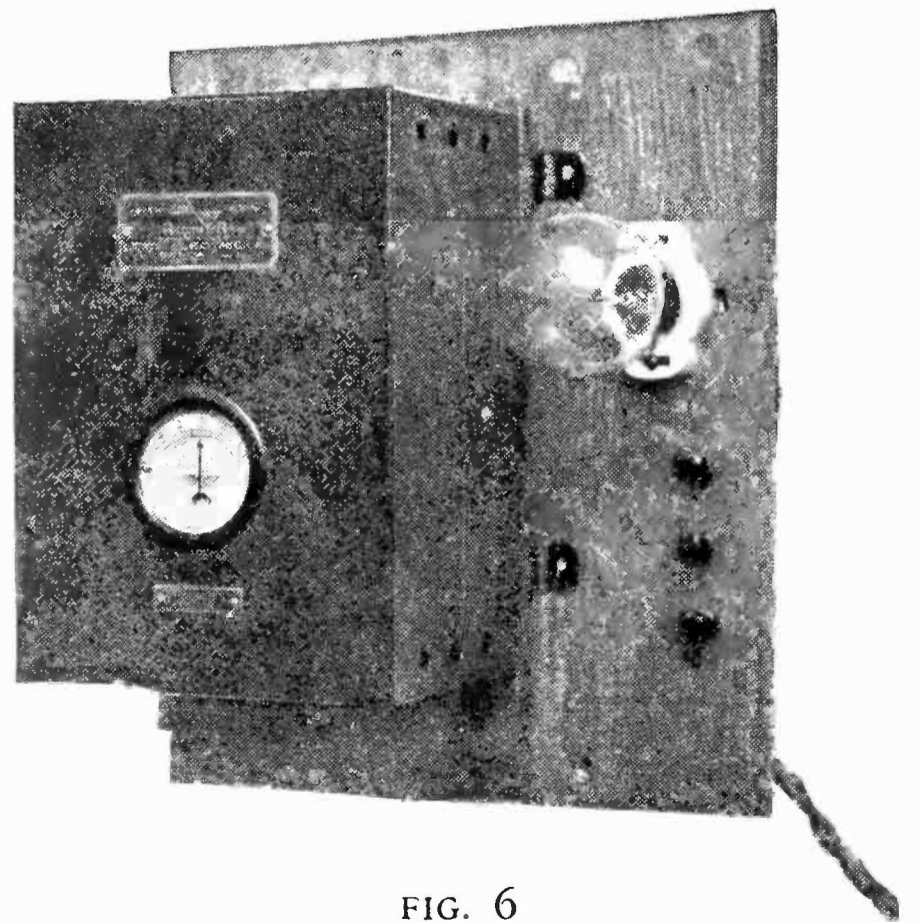

FIG. 6

The A battery rectifier permanently mounted on the station wall, and wired for charging both A and B batteries

condenser. In most cases this is best accomplished by removing one of the machine screws from the condenser end plate (generally a six thirty-two) and substituting a longer and headless screw which will take the threaded support on the coil.

The very compact construction of the set is made possible by the use of "Resisto-Couplers" (Daven Radio Company), in the three-stage resistance-coupled amplifier. The Resisto-Coupler clips the coupling resistance, grid leak, and isolating condenser into a small unit which fits nicely between the tubes and under the jacks. A five inch base-board was used.

The circuit is identical with that described in Mr. Bouck's original article, except that the .00025 mfd. stabilizing condenser is more effective between the grids of the first two amplifying tubes (not counting the reflex tube), rather than between grids one and three.

OTHER COUPLING RESISTANCES

SINCE the article on resistance-coupled audio amplification, by G. Y. Allen, in the May RADIO BROADCAST, several manufacturers have appreciated the possi-

bilities of this system, and several new resistors, suitable for coupling resistances, have been placed on the market. Any of the following are now easily obtainable and are equally efficient:

The Bradley-Ohm.

The Daven Resistors (fitting the Resisto-Coupler).

The Lavite.

The Ward-Leonard non-inductive resistances.

AN A BATTERY RECTIFIER PERMANENTLY INSTALLED FOR CHARGING B BATTERIES

THE vibrating rectifier described in the B. battery charging article in last month's RADIO BROADCAST is shown permanently and conveniently mounted in photograph 6. This makes a very business-like installation. The rectifier, lamp, and terminals are mounted as a single unit, and wired to the battery and to the station switch-board from which the rectifier is controlled. Binding-posts are also provided for connection to batteries other than the cells permanently wired. Three posts are provided, one positive, for

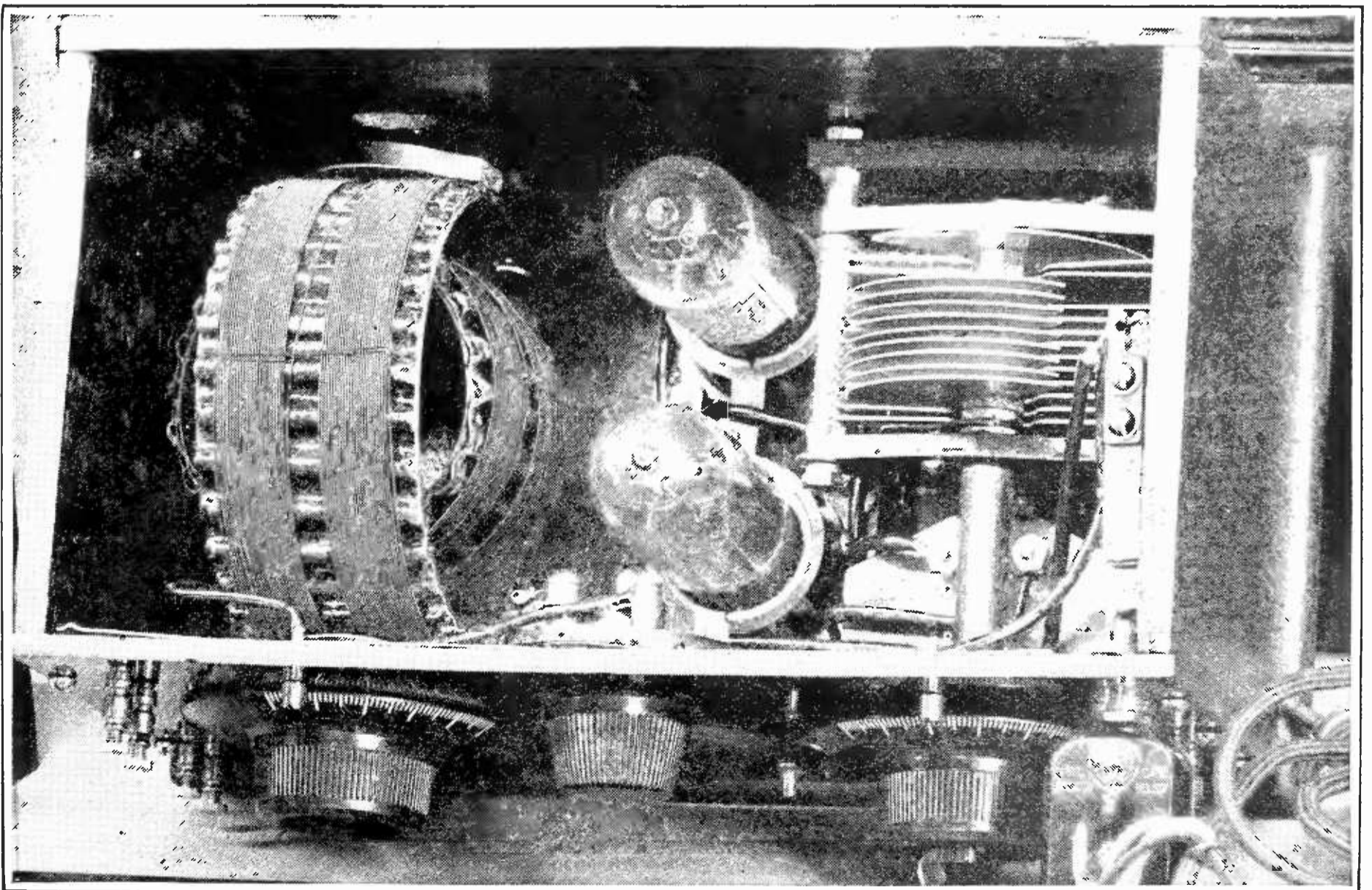

FIG. 8

A receiver built by Mr. Brown, using his corrugated pasteboard inductances

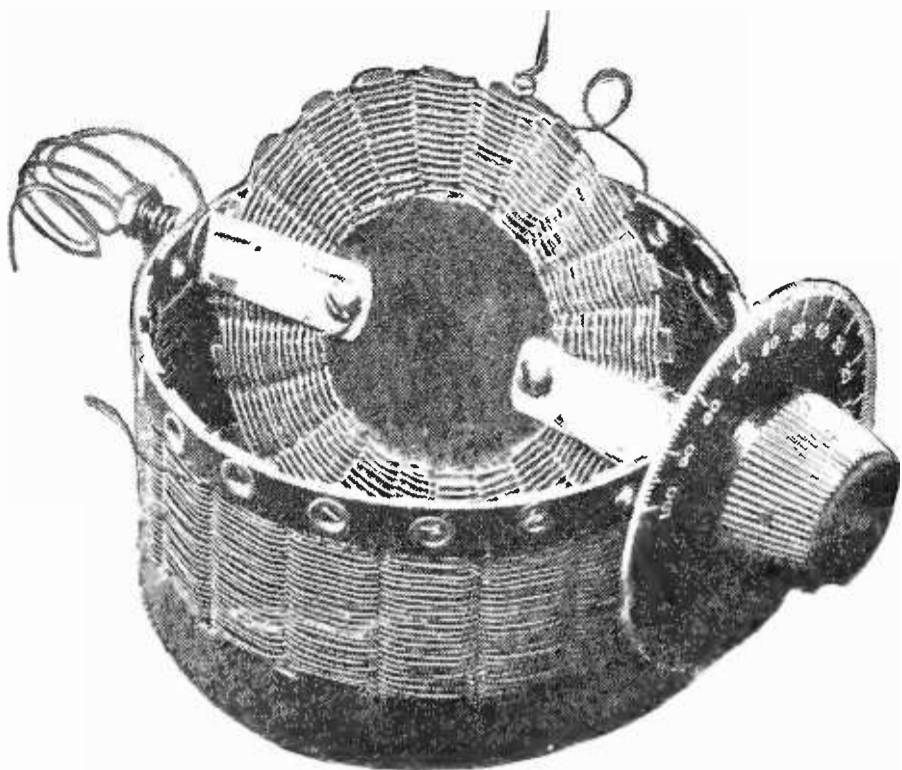

FIG. 9

A spider-web variocoupler. Unusual, and perhaps a little more efficient than the ordinary

both A and B batteries, and two negatives, one for A and the other for B. The use of a common plus post, which runs to the ammeter on the front of the rectifier, makes it possible to employ this meter in both A and B battery circuits.

HOME MADE ULTRA EFFICIENT INDUCTANCES

PHOTOGRAPHS 7, 8, and 9 show the highly efficient inductances made by one of our readers, Mr. C. H. Brown. Theoretically, the most efficient inductance would probably be a coil of self-supporting bare wire wound on air. The dielectric losses and distributed capacity of this coil would be reduced to a minimum. However, such inductances are hardly practical, and the nearest approach to this theoretic ideal is found in honeycombs, spider-webs, and the coils wound by Mr. Brown.

The winding form in Fig. 7 was made from the common corrugated pasteboard used in packing photographs and for making heavy pasteboard boxes. A strip of the material, cut to the desired width, is merely bent backward into a tube, and fastened with glue or eyelets.

Fig. 9 shows a spider-web variocoupler that will appeal to our less conventional readers. The form on which the primary is wound was originally a strip of ordinary cardboard (or

fiber may be used), about three and a half inches high and sixteen inches long. Slots are cut to three quarters of an inch from the lower side, leaving half inch segments with a quarter of an inch between them. The form is then bent and permanently made into a circular tube. The finished form must have an odd number of slots and segments. After the wire is wound, the top of the coil is encircled with a strip of cardboard made fast with glue, or eyelets as Mr. Brown has done. The secondary of the coupler is an ordinary spider-web.

BUILDING YOUR OWN LAB

THIS month's suggestion is a handy little device that only recently found its way to our own work-bench. Photograph 10 shows the Nestor "Bend-Rite"—a genuine aid to the art of neat wiring. It is a wrench arrangement that may be used for bending large and small bus-bar wire, and for making eye holes to pass both number six and number eight screws. It is in this last operation that the "Bend-Rite" shows its true worth, and the behind the panel neatness of the receiver shown in Fig. 5 pays tribute to this handy device.

The "Bend-Rite" is made to be permanently screwed to the work-bench or table, but the experimenter will probably find it more convenient to clamp the tool in a vise, and shelve it when not in use.

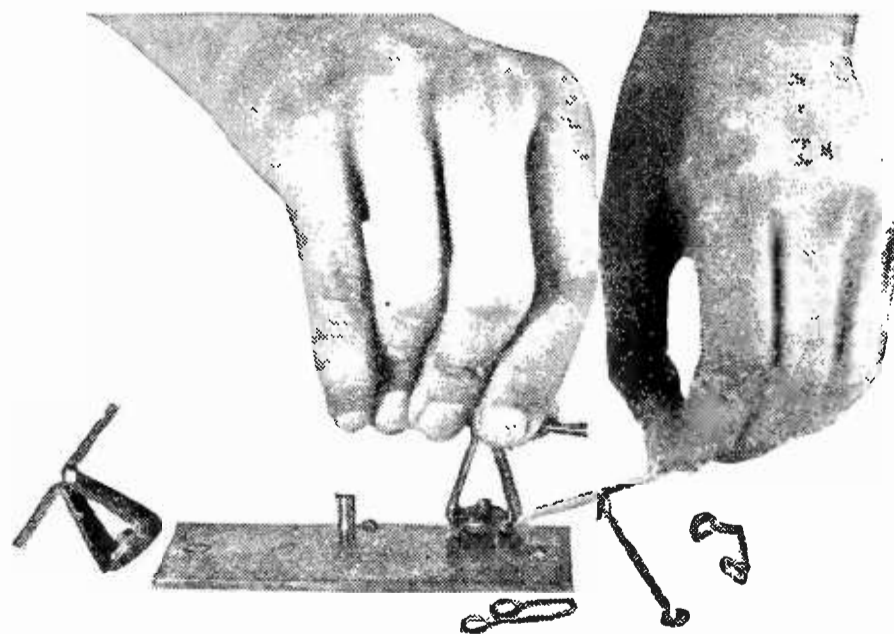

FIG. 10

The "Bend-Rite" arrangement. This little wrench device may also be used for making excellent tail-washers from short lengths of bus-bar wire

Supplemental List of Broadcasting Stations in the United States

LICENSED FROM MAY 17 TO JUNE 13 INCLUSIVE

CALL LETTERS	LOCATION	KILOCYCLES	WAVE-LENGTH	POWER (Watts)
KFPO	Denver, Colo.	1300	231	500
KFPT	Salt Lake City, Utah	833	360	500
KFOA	St. Louis, Mo.	1150	261	50
KFQD	Anchorage, Alaska	1070	280	100
KFQE	Colorado Springs, Colo.	1340	224	5
KFQF	Minneapolis, Minn.	1340	224	10
KFQG	Los Angeles, Calif.	1330	226	100
KFQH	Hillsborough, Calif.	1300	231	50
KFQI	Culver City, Calif.	1280	234	100
KFQJ	Oklahoma City, Okla.	1270	236	50
KFQK	Fayette, Mo.	1270	236	10
KFQL	Muskogee, Okla.	1190	252	20
WCAY	Milwaukee, Wis.	1130	266	250
WDBI	St. Petersburg, Fla.	1330	226	10
WDBO	Winter Park, Fla.	1250	240	50
WDBP	Superior, Wis.	1150	261	50
WDBQ	Salem, N. J.	1280	234	10
WDBR	Boston, Mass.	1170	256	100
WDBS	Dayton, Ohio	1060	283	5
WDBT	Hattiesburg, Miss.	1270	236	10
WDBU	Skowhegan, Maine	1160	258	10
WDBV	Fort Wayne, Ind.	1160	258	100
WDBW	Columbia, Tenn.	1120	268	20
WEBH	Chicago, Ill.	810	370	1000
WFBW	Cincinnati, Ohio	970	309	750
WJAB	Lincoln, Neb.	1310	229	100
WJAZ	Chicago, Ill.	1120	268	20
WKBF	Cranston, R. I.	1050	286	500
WLBL	Stevens Point, Wis.	1080	278	500
WMAZ	Macon, Ga.	1150	261	100
WQJ	Chicago, Ill.	670	448	500
WSAU	Chesham, N. H.	1310	229	10
WSAV	Houston, Texas	833	360	100

LIST OF BROADCASTING STATIONS DELETED MAY 1 TO MAY 30

CALL	LOCATION	CALL	LOCATION
KDZO	Denver, Colo.	WGN	Chicago, Ill.
KFCH	Billings, Mont.	WHAP	Decatur, Ill.
KFDR	York, Nebr.	WIAU	Le Mars, Iowa
KFLP	Cedar Rapids, Iowa	WMAP	Easton, Pa.
KFLY	Fargo, N. Dak.	WOAD	Sigourney, Iowa
KZN	Salt Lake City, Utah	WPAP	Winchester, Ky.
WBBE	Syracuse, N. Y.	WSAX	Chicago, Ill.
WBL	Anthony, Kans.	WTAH	Belvidere, Ill.

MEXICAN BROADCASTING STATIONS

CALL LETTERS	LOCATION	KILOCYCLES	WAVELENGTH	POWER (Watts)
CYB	Mexico City	545 to 857	350 to 550	
CYL	Mexico City	545 to 857	350 to 550	
CYR	Mazatlan	545 to 857	350 to 550	250
CYX	Mexico City	545 to 857	350 to 550	

TOTALS

Number of U. S. broadcasting stations	601
Number of Canadian broadcasting stations	44
Number of Cuban broadcasting stations	34
Number of Mexican broadcasting stations	4

The D X Con



MRS. EVA L. RHODES

Who won the first prize for ready-made receivers in RADIO BROADCAST'S third distance receiving contest. She received a MuRad MA-15, six-tube radio frequency set

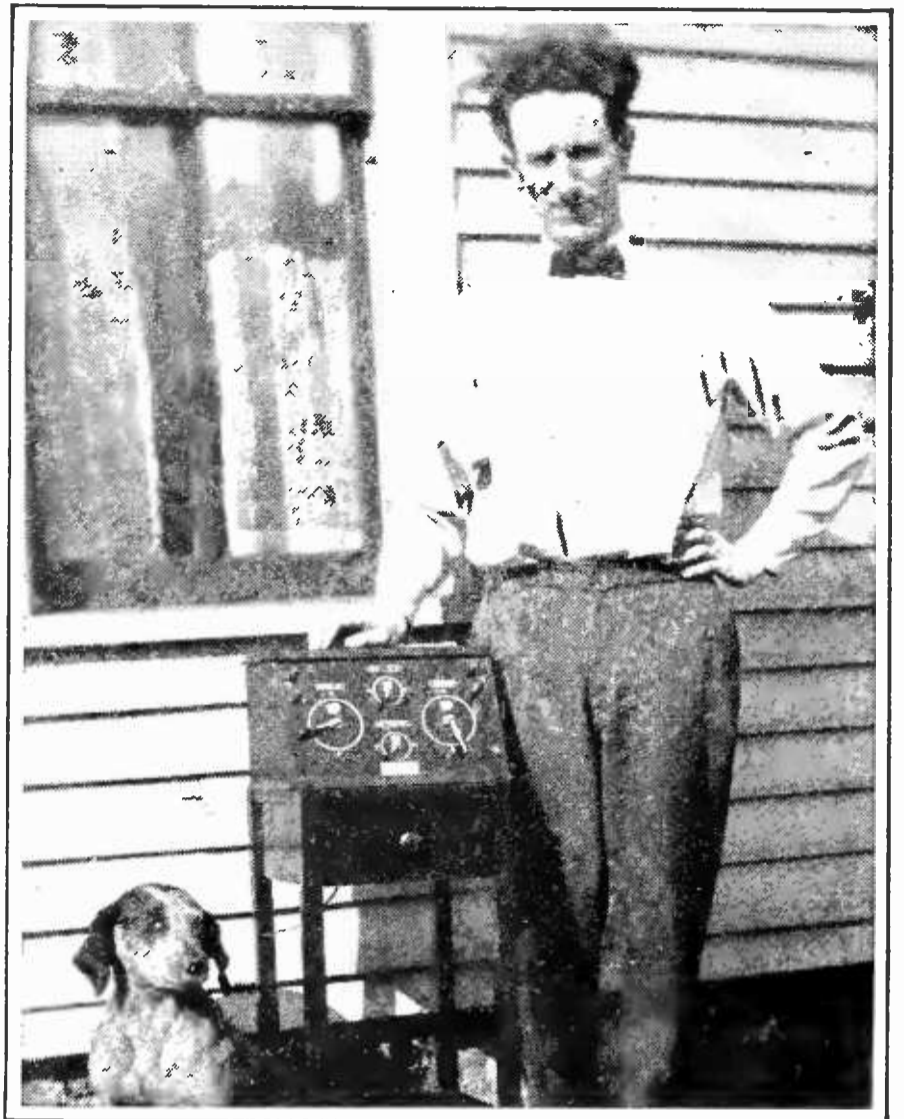

O. B. EVANS

Of Mount Pleasant, Michigan, whose one-tube Michigan Midget receiver, appearing in the photograph together with its owner and his dog gained second place in the contest with a distance of 84,620 miles. His prize was a Fada neutrodyne receiver, model "160"

MEET the winners of RADIO BROADCAST'S third annual distance contest. Last month, we announced their names and the prizes they received, but the scarcity of available space in the magazine made it necessary to hold over their photographs until this number. These are the six fortunate ones out of a very large group of contestants who brought all their dial twisting cunning to win the six prizes, three for home-built receivers, and three for ready made sets, in the contest recently closed.



M. F. WINNE

Of Webster Groves, Missouri, second prize winner in the home-built receiver group. His home-made neutrodyne brought in a total distance of 115,088 miles. The photograph of Mr. Winne's set showed one of the neatest and best built we have seen

Those who entered the contest and were not successful and those who did not enter it and have since wished they had, and those who are interested in distance reception anyhow all doubtless would like to know what sort of receiver did win out in the two groups.

THE RECEIVERS THEY USED

MRS. EVA L. RHODES, of Utica, New York, who logged a distance of 85,510 miles used a Paragon RA-10 receiver with a DA-2 detector-amplifier unit of the same manufacture and a 10-R radio-frequency amplifier. The other equipment included a Fibretone loud speaker, and a Malone-Lemmon Control-o-Meter.

O. B. Evans, of Mount Pleasant, Michigan, who came in second in the manufactured set group, used a Michigan Midget one-tube receiver. He used Brandes receivers, and his antenna was an inverted L type 102 feet long which was alternated with an indoor cage antenna containing 61 feet of No. 14 wire.

Alex. B. Nicol, of Bogota, New Jersey, who won third place with his Atwater-Kent No. 10 Radio-dyne, logged a total distance of 68,520 miles. He used an 80-foot single wire antenna, 25 feet high, Western Electric phones, and Atwater-Kent loud speaker.

test Winners

HOME-MADE WINNERS

DR. W. C. WOLVERTON, of Linton, North Dakota, who won the first place in the home-built set group, used an assembled neutrodyne receiver to gain his mileage of 121,535. He used the following parts:

Freed-Eisemann neutroformers and neutrotons
 WorkRite non-microphonic sockets
 All-American audio transformers
 Dubilier micadons
 Star Rheostats
 Standard Two-Circuit jacks
 Freshman .006 mfd, fixed condenser (mica).



KENNETH DANIELSON

Of Thermopolis, Wyoming came in a good third for the receivers in his class with a distance of 135,190 miles. His receiver was also a home-assembled neutrodyne which was built from Freed-Eisemann parts

Carter .04 mfd. fixed condenser; Carter rheostats; Federal audio transformer; Royal sockets; Ezytoon dials; Western Electric phones.

His antenna is a single wire, 90 feet long, stretched from a window of his house to a tree, 45 feet from the ground and free from all obstructions. His location is apparently an excellent one for receiving.

Kenneth Danielson, of Thermopolis, Wyoming, whose total distance of 135,190 miles won him third place, used a neutrodyne receiver which he assembled from Freed-Eisemann parts. Most of his reception is done on Baldwin phones, although he uses a Magnavox R-2 loud speaker on strong signals. His antenna is a single wire 65 feet long, 35 feet above ground.

Mr. Winne got the parts for a Roberts two-tube knock-out with one stage of audio, and Mr. Danielson the parts for a Roberts set as his prize.

Baldwin and Brandes phones
 Murdock multiple plug
 Baldwin loud speaker, with Weston plug
 additional audio amplifier unit using 2 Air-Way audio transformers

M. F. Winne, of Webster Groves, Missouri, won second place in the homebuilt receiver class with his distance of 115,088 miles. His home-built neutrodyne is an exceptionally well made one. Besides home made neutrodyne parts, he used



DR. W. C. WOLVERTON

Of Linton, North Dakota, whose home-built neutrodyne receiver won first place in that class with a logged distance of 121,535 miles. The set is excellently assembled and neatly wired. His prize was a complete set of parts for a Haynes super-heterodyne

CONCLUSIONS

THE neutrodyne receivers seem to have it by acclamation in the home-built receiver class, for every one of the winners in that group used such a receiver. Some of them were built entirely by the constructor, and others used some manufactured parts. The winners in the other group also depended on radio-frequency amplification, very largely. Mrs. Rhodes attained success using a radio frequency unit ahead of her regular receiver.

The letters which came in with the contest entries were almost unanimous in their condemnation of the single-circuit regenerative receiver, and almost all reported continuous interference from this type of set. It is distinctly worth noting that excellent distance was attained by these contest entrants all of whom used non-radiating types of sets.

In later issues, we shall publish photographs and brief descriptions of some of the very excellent sets which were entered in the contest.



ALEX B. NICOL

Of Bogota, New Jersey came out third among the contestants with ready-made receivers. He logged 68,520 miles with an Atwater-Kent No. 10 Radiodyne, and received a Sonochorde loud speaker as a prize

A Word About Radio Broadcast's Knock-Out Receivers

How They Came to be Featured so Strongly—How to Tell Which of Them Will Best Suit Your Needs

By ARTHUR H. LYNCH

WE FEEL perfectly justified in stating that no group of radio receivers, with the possible exception of the neutrodyne and the superheterodyne has achieved anything like the success and favor among the radio public that our own Knock-Out series has received. And so we tell some of the story.

From the first numbers of RADIO BROADCAST, its editors have been of the opinion that whistling receivers were a menace not alone to good reception but to the entire radio industry. Many of you, who have followed our activities will remember that hardly a number appeared that did not contain some reference to this nuisance.

Many reputable manufacturers did not agree with us in our stand, and some of them went so far as to tell us that unless we ceased our criticism of the receivers on which they were making their living they would discontinue advertising with us. This magazine, like most others, depends to a great extent on advertising revenue for its life. We held a council of war and decided to stand by our guns and unless we could tell the truth, not half-truths, we would discontinue publishing in the radio field. Some advertisers did pull away from us and we lost their business, but we gained something far more valuable—the confidence of our readers. Other advertisers began to believe our doctrine and realized that in the long run the family that could afford an expensive receiver would not buy it if the entertainment it would provide could be and would be subject to the whims of other families in the neighborhood operating interfering receivers. Then, too, we had the parts manufacturer and the retail dealer to contend with. Contention it was, because neither would agree that a policy that would reduce sales, even temporarily, was a good policy to pursue.

HUMAN NATURE, BLOOPERS; THE GOLDEN RULE

THERE isn't any problem to it," said the manager of one radio store. "Human nature is human nature, and just as long as the cheapest receiver that brings in long distance is one of your so-called "bloopers" the public is going to buy it. The golden rule days have not yet arrived. And from a purely business standpoint, it is necessary for me to sell these receivers to stay in business, because if I didn't someone else would, and the money is just as good to me as to any one else."

Eminent radio experts and many self-appointed radio engineers went to a lot of trouble to advocate the continuance of the sale of receivers that could and did radiate. Their arguments have appeared in the radio sections of many newspapers as well as in some of the radio monthlies.

One of the simplest methods to show the menace of radiating receivers was to have every listener in this country attempt to listen for the same broadcasting station at the same time. By cooperating with *The Wireless World & Radio Review* and British Broadcasting Company in London, and the broadcasting stations here, we were able to carry on our transatlantic tests last November. American broadcasting stations kept silence while listeners throughout our country endeavored to pick up signals from England. The reports from all who took part in these tests show that the greatest drawback was the interference caused by radiating receivers.

THEN CAME THE CAUSTIC EDITORIALS

RADIO editors in all sections of the country began writing highly vitriolic editorials condemning the bloopers. What could be offered as a substitute? What type of receiver would be as easy to operate, as selective, and as economical? There was but one such receiver that we knew of (excepting,

of course, the commercial type neutrodynes, reflexes and other non-radiators) that would fill the bill for those who rolled their own. We had tried every receiving gadget we could lay hands on, but the search was fruitless until we happened to get into the laboratory of a small radio company in New York. Here we found the single-tube reflex which was described in our November number, and because it was so far superior to any single tube receiver we had ever seen, we called it a "Knock-Out." It was from this receiver that the Knock-Out series developed.

There is little need, therefore, further to expand the merits of the Knock-Out one-tube reflex. It is, we believe, the best all-round single-tube receiver ever made. It is cheap, easy to assemble, and is easy to operate and it does not cause interference.

OVER-ENTHUSIASTIC CLAIMS

IN PRESENTING new developments in receiver design to our readers we have always attempted to use moderation in making claims for their performance. Sometimes this modesty on our part has caused easily impressed construction enthusiasts to build inferior receivers described in other publications for which glowing and frequently very optimistic claims were made. The result has been that many of those arrangements which have been heralded from the housetops as wonderful have been discarded for more reliable circuits that have appeared in our pages. The following unsolicited letters, which are but two among hundreds, indicate quite clearly how this system of conservatism is working out.

In the November number of RADIO BROADCAST, which we accidentally ran across a short time ago, "young son" and I read Mr. Harkness' article describing the "knock-out" one-tube reflex. Now we had built a number of sets, some good, some bad and others indifferent. Particularly did we expect great things of a one-tube reflex that was widely heralded last summer, only to be disappointed by its working in our hands.

However, the "knock-out" looked good to us and we proceeded to build it, and let it be said that as a result of our first night with it we were tickled pink. On K S D with our Western Electric loud speaker it filled the house. In rapid succession then came W O O, W M C, W O A W, W F A A, W D A P, W C A E, W O C, and W E A F. It was Sunday night and hearing W O C announce organ music, we adjusted the dials to tune-in more clearly and then, after listening to an organ selection that came booming in, judge of our surprise on hearing W E A F announce the Skinner organ program instead. The "knock-out" has now a permanent place in our cabinet alongside a much more expensive and pretentious set.

JOHN N. McCAUGHAN, M. D.,
St. Louis, Mo.

Three rousing cheers for RADIO BROADCAST and the Roberts reflex set. First we had the Harkness, which was a dandy set for local broadcasts, and now we have the Roberts that is fine for local and excellent for distance too.

Our problem here is to get by our four 500-watt stations operating simultaneously on 276, 360, 395, and 469 meters and get KPO at Frisco and KGO at Oakland on 423 and 312 meters respectively, and taking into consideration also that a set good for 1000 miles east of the Rockies will do well to cover half that distance on the Pacific slope. My receiver will do this, and in addition, gives me more volume on the locals than the Harkness with an extra stage of audio. . . . The idea of seeing a hookup through to the bitter end is an excellent one, and a relief from the galaxy of new hookups constantly appearing elsewhere.

G. L. KING,
Los Angeles, Cal.

HOW THE RECEIVER DEVELOPED

THERE are many who desire volume enough for loud speaker operation at all times and for them we have built up the two- and three-tube sets.

In designing these receivers, we have always endeavored to prevent our search for really satisfactory results from running away with our sense of duty to our readers in the matter of expense involved. For this reason the design of the Knock-Out two-tube and Knock-Out three-tube sets was made with a view to keeping the cost to the builder down as low as was consistent with good operation. Then, too, it was necessary to include in the design only such units as a builder could reasonably expect to find in the small dealer's shop or could be made at home with comparative ease.

But, despite these efforts improvements came more rapidly than we bargained for, and where the builder can afford a set employing two or more tubes we feel that it is better for him to use the system described by Walter Van B. Roberts in our April and May numbers or by J. E. Roberts in this number.

Our tests on the Roberts receiver indicate that it is almost as far superior to the single-tube reflex as that receiver was above other single-tube arrangements. For selectivity, economy of operation, ease of adjustment, etc., we know of no other receiver—tube for tube—that compares with it.

That does not mean that the builder of a receiver of the older type should junk it if it is operating satisfactorily. If you are one of those builders who builds a set for the entertainment received from broadcasting and your present receiver gives satisfaction, keep it.

The Vacuum Tube as an Amplifier

Explaining the Action of the Tube in Radio- and Audio-Frequency Circuits—The Advantages of Amplification at Radio Frequencies

WHAT MAKES THE WHEELS GO 'ROUND: VI

BY WALTER VAN B. ROBERTS

For those who have wondered just "how and why" the vacuum tube works in radio- and audio-frequency amplification, here is a clear and concise answer to their perhaps unasked questions. Mr. Roberts discusses regeneration, inductive, or tickler feed-back, and the relation that the size of tubes and their elements bears to this phenomena. As the other articles in this series, this article may be read as an entity in itself, although it fits in with the others in the group.—THE EDITOR

WHEN radio waves of the frequency for which the antenna circuit is tuned are coming in, the high-frequency currents flowing in the coil produce high-frequency variations of the grid potential which in turn produce high-frequency currents (of considerably greater energy) in the plate circuit. If we could "feed back" some of this high frequency energy to the antenna circuit it might help the radio waves in their job of maintaining the high frequency current in the antenna circuit. This can be done in several ways. A very common method is shown in Fig. 24. To make the circuit conform to actual practice, the grid leak and condenser system of detection is shown and a fixed condenser is shunted around the phones to offer the high frequency currents a path of lower reactance than

through the phones. (This reactance is, however, so high for voice-frequency currents that they mostly go through the phones.) The essential addition to the circuit is, however, the coil in the plate circuit. This is called the "tickler" coil and upon being brought up near

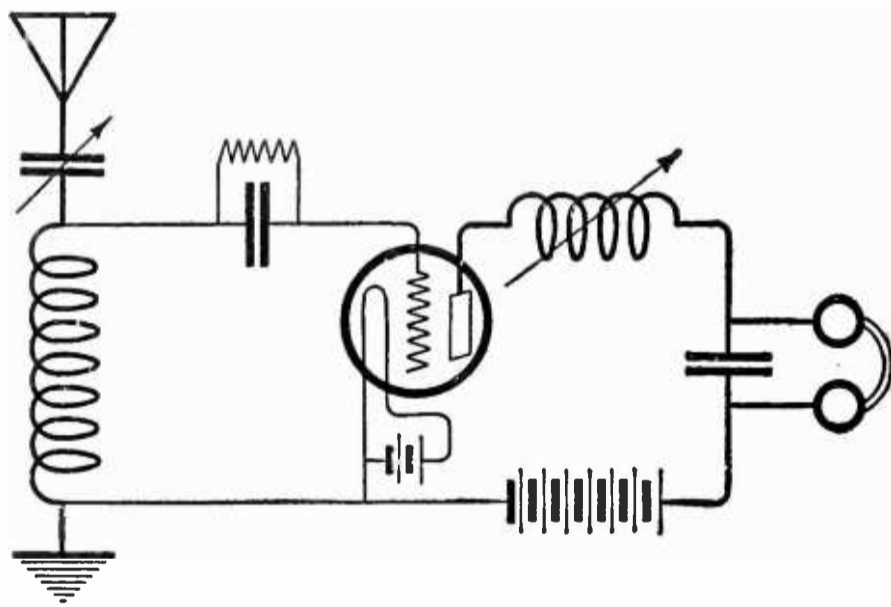

FIG. 25

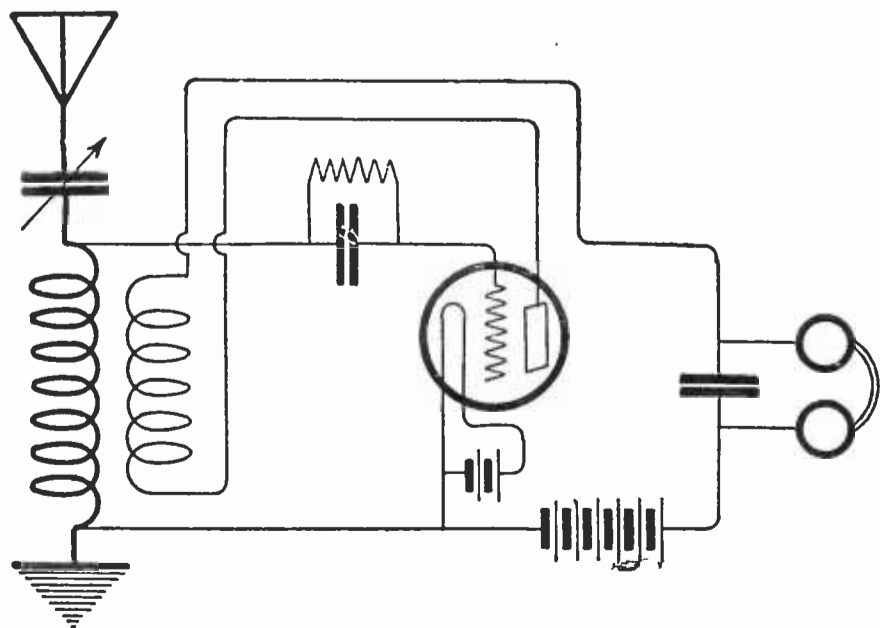

FIG. 24

the antenna coil its mutual inductance or transformer action affords a means by which energy from the plate circuit is fed back into the antenna circuit. The tickler must be connected the right way too, for if the connections are reversed its effect will be to reduce the antenna current instead of increasing it. The nearer the coils are brought together the greater will be the effect. If brought too close together a point will be reached where more power is being fed back to the antenna circuit than is being dissipated therein by heating the resistance of the circuit. When this happens all

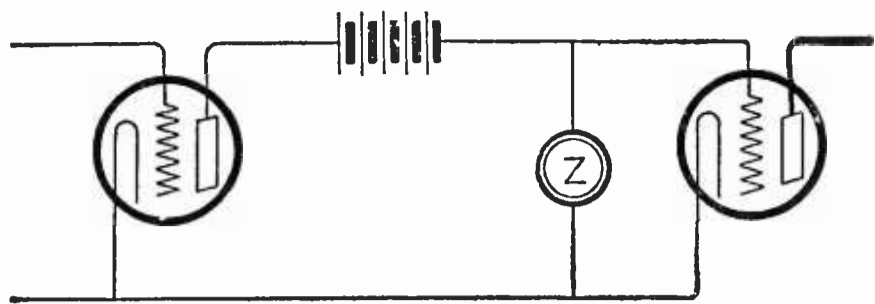

FIG. 26

the currents build up rapidly to an amplitude so great that our assumption $i_p = K (B + \mu \times \text{grid potential})^2$ is no longer correct, and the amplifying power of the tube has fallen to a value where only as much energy is being fed back to the antenna circuit as it is dissipating. The tube is then said to be oscillating and will continue to oscillate even if the radio waves cease coming in. The loudest signals are obtained just before the tube "breaks into oscillation." Signals can be received even while the tube is oscillating if the oscillation frequency is kept exactly the same as the carrier wave frequency, but this is very difficult.

50. PLATE VARIOMETER REGENERATION

FIG. 25 shows another common way for obtaining regeneration. The variable inductance in the plate circuit is not near enough to the antenna coil to have any appreciable "tickler" effect, but it is nevertheless capable of producing regeneration as follows: just as the radio-frequency currents flowing in the coil of the antenna circuit cause radio-frequency fluctuations of the grid potential, so do the radio-frequency currents in the plate circuit cause fluctuations in the plate potential. On account of the close proximity of the plate to the grid the fluctuations of plate potential affect the grid potential and it can be shown that the effect is to re-enforce the grid potential fluctuations caused by the antenna current. If the variometer or variable inductance is gradually made greater, the amount of regeneration will increase until, just as with tickler regeneration, the tube breaks into oscillation. (If a high resistance or a large condensive reactance

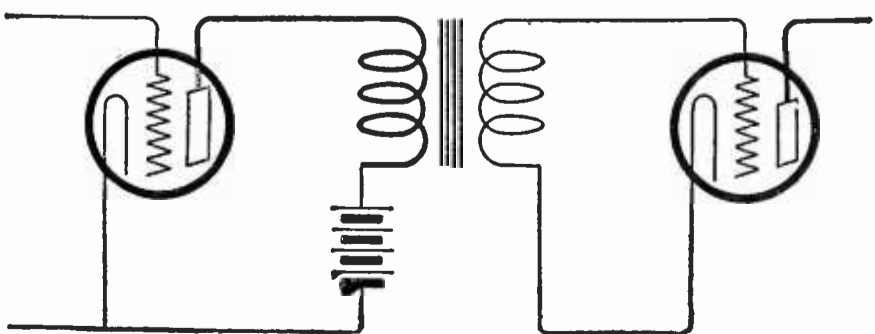

FIG. 27

were used in the plate circuit instead of the inductance there would also be fluctuations of plate potential, but the effect, if any, would be to diminish the grid potential variations.)

51. IMPEDANCE AND RESISTANCE COUPLING

THERE are two general methods for obtaining amplification by means of vacuum tubes. The method of impedance coupling

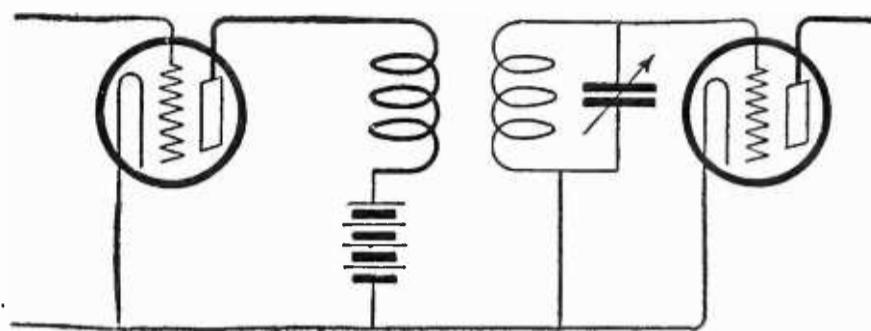

FIG. 28

shown in Fig. 26 is the one least used. The total voltage amplification attainable per stage (in Fig. 26 this would be the ratio of the alternating voltage on the grid of the second tube to the alternating voltage supplied to the grid of the first tube) cannot be greater than the voltage amplification constant of the tube, and in practice is usually considerably less. Hence to get good amplification by this method, special tubes having high values of μ must be used. The impedance indicated by

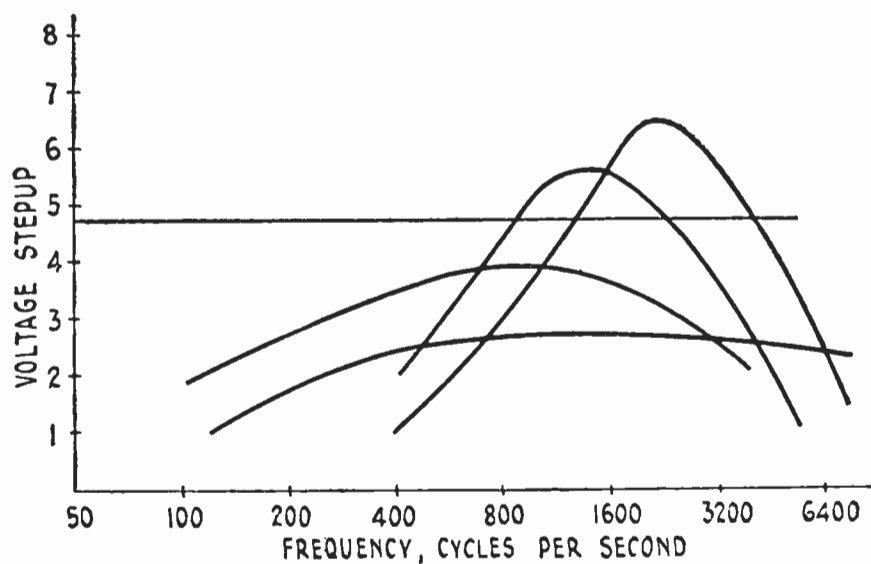

FIG. 29

the letter Z in Fig. 26 may be either a high resistance or a high reactance. The alternating grid potential applied to the first tube causes alternating current in the plate circuit. This alternating current traversing the impedance causes an amplified alternating potential difference between its terminals, and hence between grid and filament of the second tube. The coupling impedance should be several times as great as the plate impedance

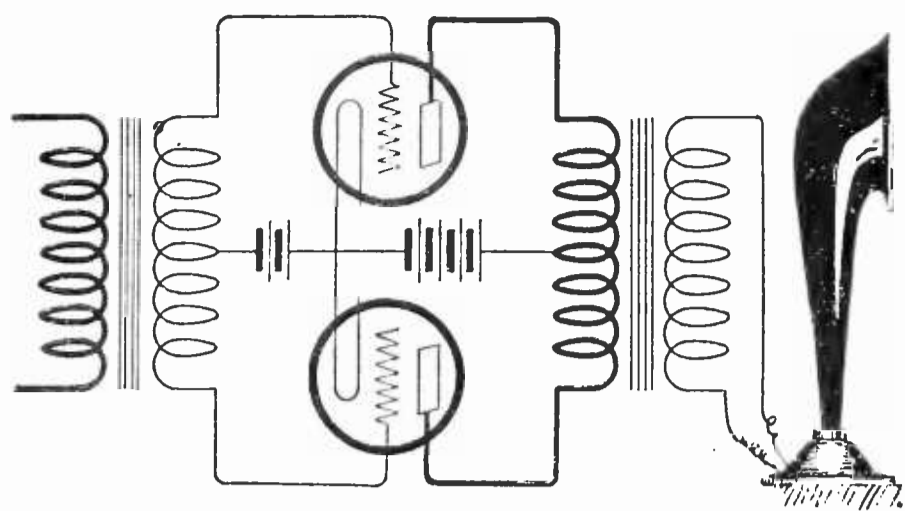

FIG. 30

of the tube in order to get good amplification and quality. A C-battery should be inserted in the wire from Z to the second grid to make the grid potential negative enough so that the addition of the alternating voltage never results in the grid attaining a positive value.

52. TRANSFORMER COUPLING

BY FAR the more common method of amplifying is shown in Figs. 27 and 28. Fig. 27 shows an iron cored transformer, designed to work over as large a range of frequencies and with as nearly equal efficiency, as possible. Fig. 28 shows a "tuned" transformer, designed to work only at the frequency to which it is tuned. In general, transformer coupling is different from impedance coupling in that the tube is not called upon to amplify voltage so much as to amplify power. The transformer receives the amplified power at a somewhat amplified voltage and delivers it to the grid of the next tube at a very much higher voltage. The increase of voltage is mostly effected by the transformer, while the amplification of the power is *entirely* due to the tube. If the greatest gain per stage is the only objective, the transformers should be designed for an "impedance match" with the tubes. To see what this means suppose that there were only one or two turns of wire on the primary. No matter how low the impedance of the primary, the current delivered to it will be limited to a small amount by the high plate impedance of the tube, which is in series with the primary. This small current will not deliver much power if it flows through only two or three turns. On the other hand if there are too many turns on the primary, the impedance will be so high that almost no current flows through it, and again there would be very little power delivered. In between these two extremes, there is a best number of

turns and this is not far from the number of turns that makes the impedance of the primary (while the secondary is connected to the tube it feeds) equal to the plate impedance of the tube. A similar line of reasoning shows that there is also best value for the number of turns on the secondary.

53. AUDIO-FREQUENCY TRANSFORMERS

TRANSFORMERS designed to amplify speech or music should be made so as to amplify as nearly as possible equally all the frequencies into which the voice or music can be analyzed. As mentioned before, this means from about 30 to about 5000. It is difficult to make a transformer that will do this and at the same time give a very large voltage "step up." A compromise must be struck between good quality without much step up, and great amplification with distortion of the relative intensities of the different component frequencies. Fig. 29 shows the general nature of the performance of audio-frequency transformers.

54. OVERLOADING; PUSH-PULL AMPLIFICATION

TRANSFORMERS are not the only source of loss of quality in audio amplifiers. The effect of the curvature of the tube's characteristic is to introduce, for each frequency applied to the grid, a new current of twice the frequency. The relative strength of these double frequencies in the plate circuit must be kept small or the quality will suffer. With a given transformer in the plate circuit (or receiver if it is the last tube) about all that can be done for a given tube is to be sure that there is enough C battery to keep the grid negative (that is, the C battery should be as great as the maximum alternating voltage input to the grid) and then to use enough B battery to bring the operating point up onto the part of the characteristic that has the least curvature. Even after these precautions have

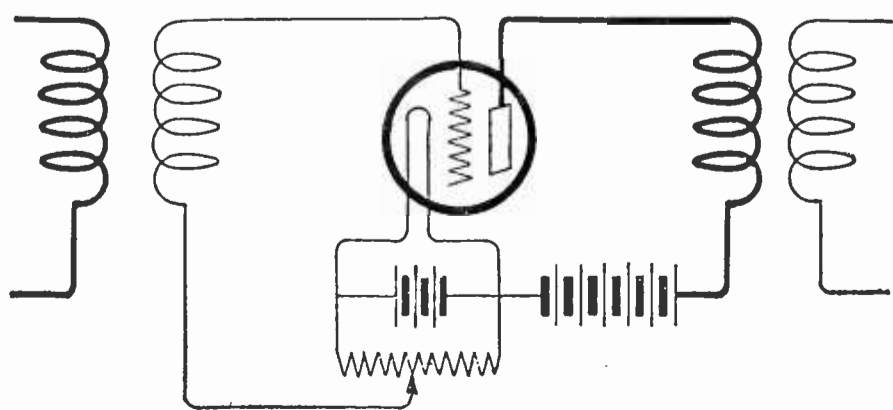

FIG. 31

CALL at your dealer's to-day and ask him to show you a Magnavox M4 Reproducer.

Try out the instrument critically; satisfy yourself that its clear tone and natural volume are sustained throughout the entire musical range; examine each essential detail of convenient size, handsome finish and sturdy construction; note that its operation requires no battery.

M4 is a definite contribution to the radio art—and one particularly welcome to the moderate income.

There is a Magnavox for every receiving set

Reproducers

- M4—requires no battery . . . \$25.00
- M1—also requiring no battery \$30.00
- R3—new model with Volume Control . . . \$35.00
- R2—same as R3 but larger size \$50.00

Combination Sets

- A1-R and A2-R—combining Reproducer and Power Amplifier in one unit . . . \$59.00, \$85.00

Power Amplifiers

- A1, AC-2-C, AC-3-C—Audio-frequency Amplifiers: one, two and three stage \$27.50 to \$60.00

To obtain the fullest enjoyment from your receiving set, equip it with the Magnavox.

THE MAGNAVOX CO.
 Oakland California
New York Office;
 350 W. 31st STREET
Canadian Distributors:
 Perkins Electric Limited
 Toronto Montreal
 Winnipeg

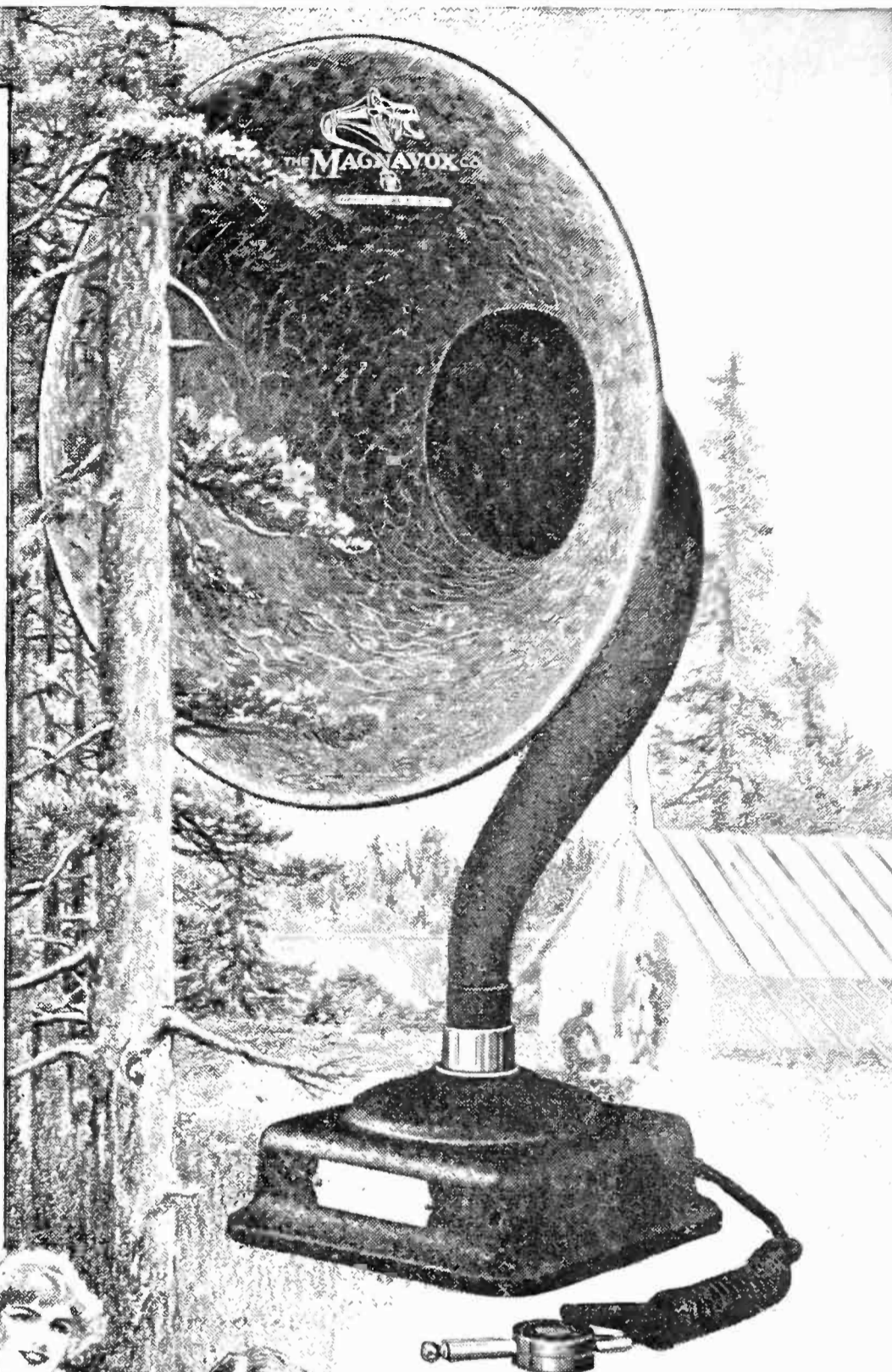

M4
 \$ 25.00

8R

MAGNAVOX ★  *Radio*

★ Tested and approved by RADIO BROADCAST ★

been taken the tube can only handle a certain input before it begins to "overload." It should be obvious, but does not seem to be generally realized, that as each successive tube in an amplifier has to handle more current than its predecessor, the tubes in the last stages should be rated for greater power than the earlier ones. Of course the amplifier may be made up entirely of tubes, each of which is capable of working in the last stage, but this is often more expensive. The Western Electric Company makes an amplifier using what is called the "push-pull" circuit (which is simplified in Fig. 30) in which the double frequencies arising from the curvature of the characteristic cancel out in the differential transformer feeding the phones. Thus a far greater volume of sound may be obtained from small power tubes without loss of quality.

55. ADVANTAGES OF AMPLIFICATION AT RADIO-FREQUENCY

UNDER the heading, detection, it was shown that the detected current varies as the *square* of the radio-frequency voltage applied to the grid of the detector tube. For this reason it is very much more effective to amplify the radio-frequency voltage before applying it to the detector tube than to amplify the detected or audio-frequency current. For instance, suppose we propose to use a stage of amplification that will give tenfold gain. If the stage is used at audio frequency it merely increases the audio currents ten times. But if it is used to increase the strength of the radio-frequency voltage input to the detector tube, the audio-frequency current output of the detector will be one hundred times as great. Another important advantage of amplification at radio frequency is that the channel of radio frequencies that must be amplified is very narrow compared to the frequencies themselves, so that all the frequencies in the channel are equally well amplified and hence there is no chance of losing quality as is the case with audio transformers that do not amplify all the

voice frequencies equally well. Finally, low-frequency noises originating in the tubes themselves on account of jarring etc., are not built up in the radio-frequency amplifier the way they are in an audio-frequency amplifier.

From the above, it is seen that radio-frequency amplification is not only desirable, but necessary for weak signals. But unfortunately, it is not easy to obtain.

56. DIFFERENCES IN AMPLIFYING OF RADIO FREQUENCIES

RESISTANCE coupling cannot be used at very high frequencies, for the low condensive reactances of the capacities which are inherent in the tubes themselves offer easier paths for the high-frequency alternating currents than the high plate circuit resistances, and hence the currents will not travel the proper paths and the amplification is spoiled. And if reactance coupling or transformer coupling be used, another difficulty arises. Under "Regeneration," we saw that when a circuit possessing a natural frequency is attached to the grid of a tube, oscillations will occur if there is enough inductance in the plate circuit. In a transformer-coupled amplifier the secondary winding, connected to the unavoidable capacity between grid and filament, constitutes a circuit of definite natural frequency, while the primary winding of the transformer feeding the next tube will often supply the necessary amount of inductance in the plate circuit. The amplifier then oscillates. Some device has to be employed to stop this oscillation. A method commonly used is called "potentiometer stabilization" and is shown in Fig. 31. By moving the sliding contact over to the positive end of the potentiometer, the grid of the tube is made positive and hence receives electrons. The energy abstracted from the oscillation circuit in pulling electrons to the grid may be enough to kill the oscillations. This is a very undesirable method because the deliberately introduced losses cut down the amplification.

WHAT the RADIO BROADCAST Laboratory does and how it does it, will be the subject of an article in this magazine for September. Since its inception, a little less than a year ago, the Lab has made many contributions of great help to radio constructors and builders, and has received widespread approval.



Ultradyne Kit

Consists of 1 type "A" Ultraformer, 3 type "B" Ultraformers, 1 Tuning Coil, 1 Oscillator Coil, 4 matched fixed Condensers.

The Ultraformers are improved long wave radio frequency transformers, specially designed by R. E. Lacault, Consulting engineer of this company and inventor of the Ultradyne.

To protect the public, Mr. Lacault's personal monogram seal (R. E. L.) is placed on all genuine Ultraformers. Ultraformers are guaranteed so long as this seal remains unbroken.

\$26.00



Send for 32 page illustrated book, giving latest authentic instructions on drilling, wiring, assembling, and tuning 6 and 8 tube Ultradyne receivers.

50c



Greater Distance!

—and the Ultradyne received it!

Faithful reproduction over great distances is no unusual performance for the Ultradyne Receiver.

The "Modulation System" of radio reception used exclusively in the Ultradyne, is a decided advance over the detector arrangement used in all other Super-Heterodynes. The "Modulation System" causes the incoming signal to modulate the oscillations produced locally just as the speech modulates the carrier wave of a broadcasting station.

This new principle, the latest development of R. E. Lacault, A. M. I. R. E., Consulting Engineer of this company and formerly Radio Research Engineer with the French Signal Corps Research Laboratories, makes it possible to get far greater distance, because of its unusual ability to provide greater rectification. Weakest signals are made to operate the loud speaker.

You will never enjoy the full pleasure of radio until you operate an Ultradyne Receiver.

Write for descriptive circular

ULTRADYNE

★ *The Improved*
SUPER-HETERODYNE

PHENIX RADIO CORPORATION
5-7 Beekman St. New York

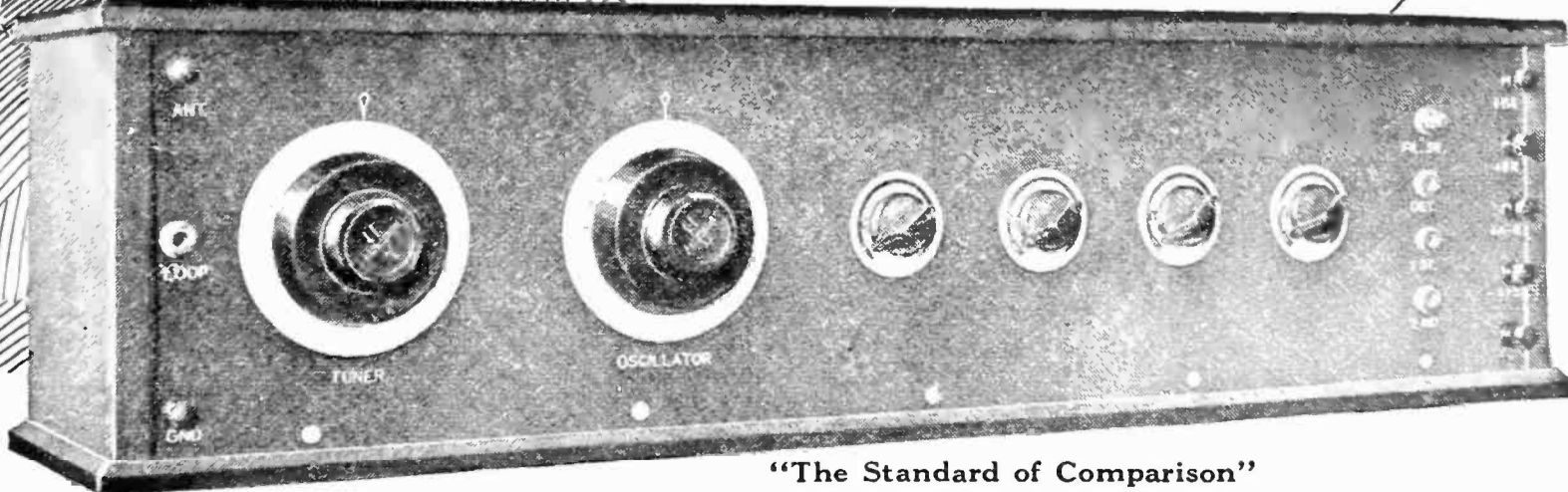

"The Standard of Comparison"

★ Tested and approved by RADIO BROADCAST ★



QUERIES ANSWERED

- WHAT IS A GOOD PUSH-PULL AMPLIFIER CIRCUIT? A. K. H., Ottawa, Canada
 HOW CAN I MAKE MY DRY-CELL TUBE OSCILLATE? W. E. M., Baton Rouge, La.
 WHAT IS THE CORRECT METHOD FOR CONNECTING AUDIO-FREQUENCY TRANSFORMERS? H. J. S., Woodhaven, L. I.

A PUSH-PULL AMPLIFIER

IN Fig. 1 is shown a standard circuit for a push-pull amplifier. It has been found that the push-pull unit works better when the signal is first boosted by a stage of straight audio amplification before it. Several push-pull amplifying transformers are now on the market, but in case you have a supply of standard transformers they may be used as follows: For the input use two standard transformers connecting the primaries in parallel and the secondaries in series. The pair of transformers (in output or input side) should each be of the same turn ratio. In the output, the primaries are in series while the secondaries are in parallel. Notice the reversed tube connections of the lower tube. This will be evident when the filament sides of two sockets are placed together.

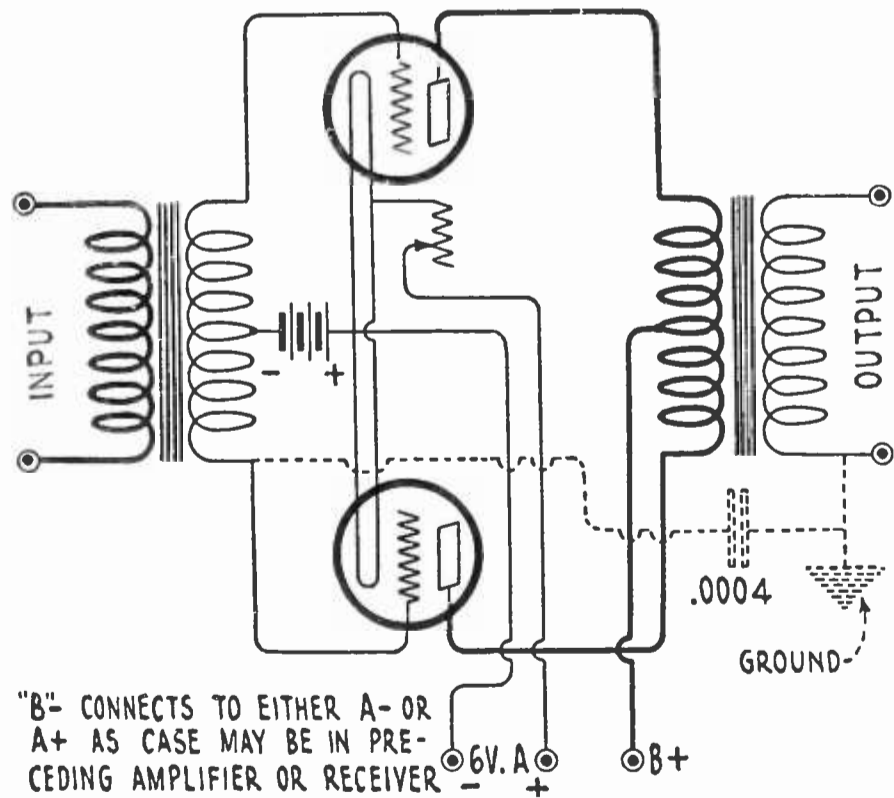

FIG. 1

DRY CELL TUBES AND OSCILLATION

IN SOME instances it has been found difficult to make dry cell tubes, especially the $1\frac{1}{2}$ -volt type, oscillate at various wavelengths. A remedy for this condition is easily provided by making the grid and plate connections of flexi-

ble insulated wire and twisting both together for 3 or 4 inches. This produces a small capacity effect which will tend to make the tube oscillate over a wide range of wavelengths. This wavelength range can be controlled by either increasing or decreasing the length of the twist.

The use of this system is not recommended for single-circuit receivers. It is especially useful for sets combining regeneration and radio-frequency amplification.

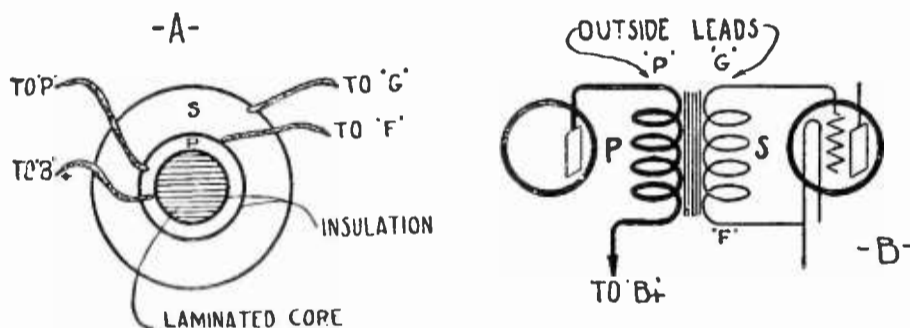

FIG. 2

AUDIO-FREQUENCY TRANSFORMER TROUBLES

MANY are the troubles that have resulted from improperly connected primaries and secondaries of audio-frequency transformers. It has been computed that the average percentage of decrease in receiver efficiency for improperly connected transformers is about 70 per cent. In Fig. 2, A shows the side view of a standard transformer. The iron core is wrapped with insulation material upon which is wound the primary; then more insulation, and on top of this, the secondary is wound. The outside or top lead of the secondary coil should be connected to the grid of one tube while the outside of the primary is connected to the plate of the preceding tube. Most manufacturers mark the posts of their transformers so the user may avoid wrong connections. The remaining ends are connected as shown in B. Any alternating energy flowing through the primary must be transformed or induced into the secondary at its maximum efficiency for best results.

The purpose of the audio-frequency transformer is to provide voltage amplification. The high potential or high voltage end of each winding is at the top or outside leads. Therefore, if the connecting leads to either coil be reversed, the high potential which should be fed to the grid, will be passed to the filament side of the tube, resulting in a decrease in amplification.

"THE CHOICE OF RADIO EXPERTS"

First~

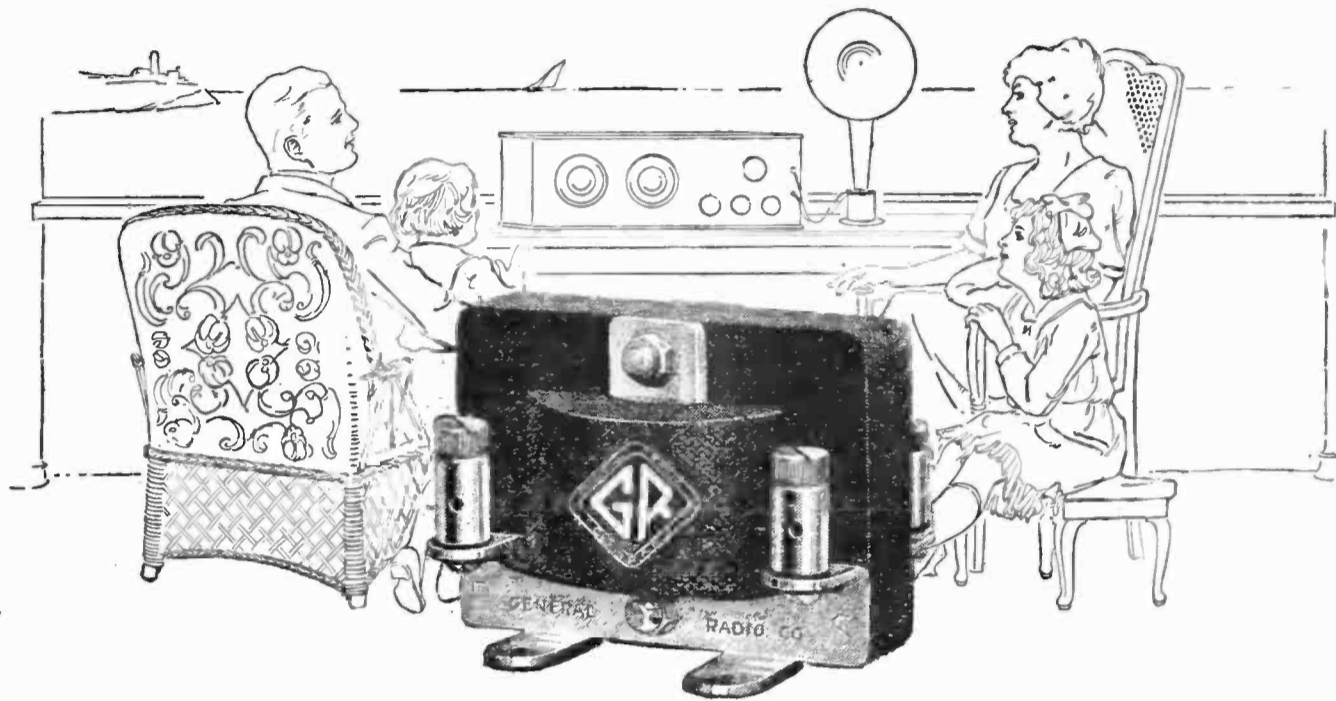

and still The Leader

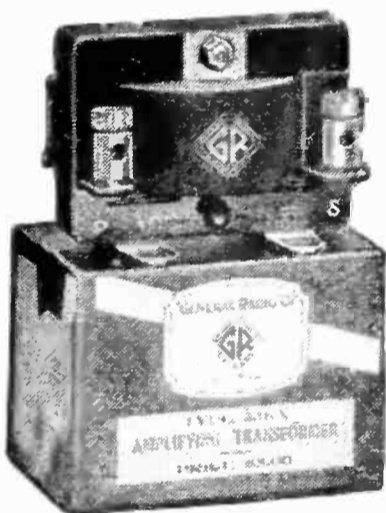

Look for the Red Cartons
with This Label

The first closed core audio frequency amplifying transformer available for amateur and experimenter use was introduced by the General Radio Company in 1917.

Since that time the General Radio Type 231-A amplifying transformer has been *First*, not only in historical leadership, but in *Volume* and *Quality* of tone.

For the fullest measure of Quality Amplification use General Radio transformers in all stages.

Turns ratio 3.7 to 1 Impedance ratio 10 to 1

Price \$5.00

Sold by Good Radio Dealers Everywhere

GENERAL RADIO CO.

Cambridge, Mass.

GENERAL RADIO CO.



Cambridge, Mass.
U.S.A.

Ask Your Dealer or Write for Our New Folder
"Quality Amplification"

★ Tested and approved by RADIO BROADCAST ★

New Equipment

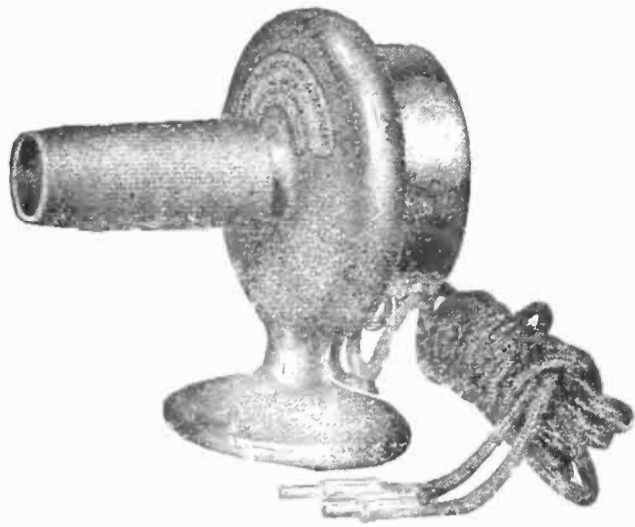

RED SEAL PHONOGRAPH ATTACHMENT

Consisting of a special Red Seal receiver attached to a heavy non-resonant metal base with diaphragm especially designed to operate the large air column of a reproducing horn. It is very sensitive to weak signals and reproduces with fidelity. Made by the Manhattan Electrical Supply Co., Inc., 17 Park Place, New York City. Price, \$5

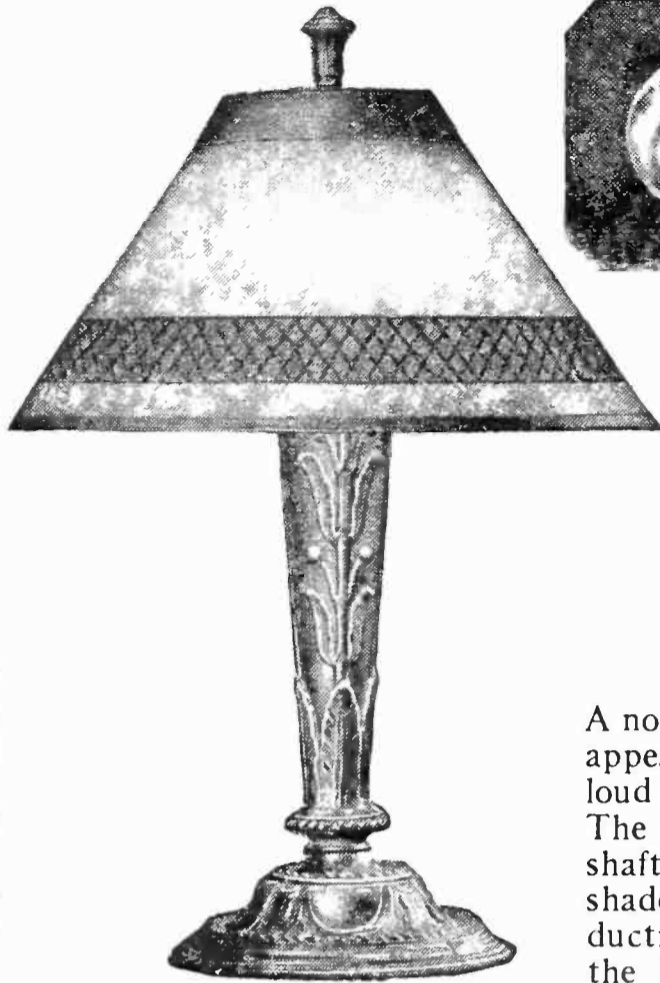

PYREX INSULATOR

An efficient antenna insulator of high mechanical strength. This insulator is reasonably light in weight and is impervious to weather. Made by the Corning Glass Works, Corning, New York. Price, 45 cents each

RADIOLAMP

A novel loud speaker which will add to the appearance of your radio corner. The loud speaker unit is located at the base. The signals travel up through the cast shaft and are reflected by the parchment shade. This gives a very mellow reproduction of the received sound. Made by the Radiolamp Mfg. Co., Newark, N. J. Price, \$35

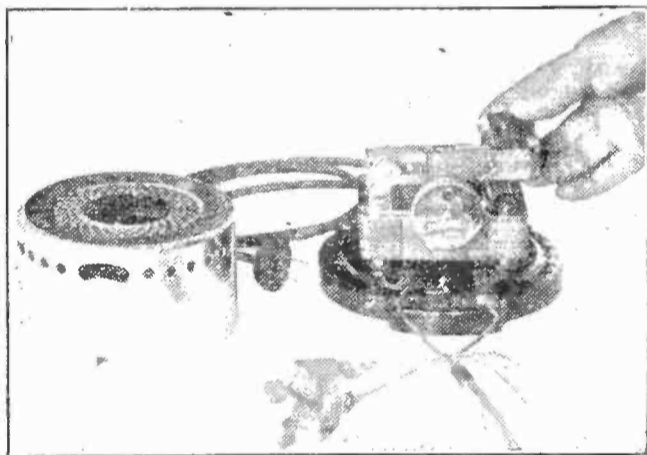

APCO BATTERY CHARGER

A newcomer among vibrating rectifiers and one which gives fine service. The noise from the vibrating arm has been pleasantly minimized. It maintains an even charging rate and its current consumption is not great. Made by the Apco Manufacturing Company, Providence, R. I.

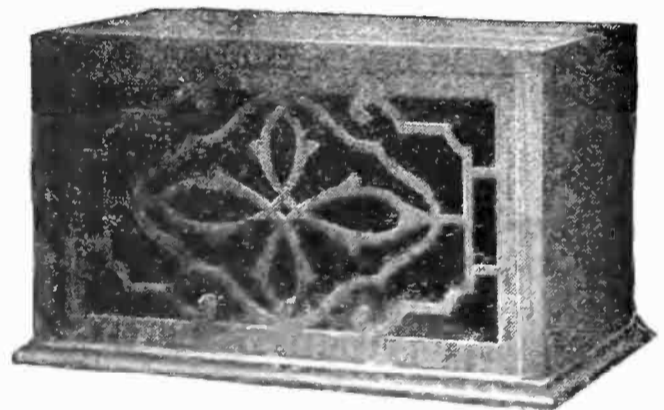

SONORA LOUD SPEAKER

A neat appearing and well made instrument employing the wooden sound chamber which has been found so satisfactory in the phonograph. The tone quality and volume are very fine. Made by the Sonora Phonograph Co., 279 Broadway, New York

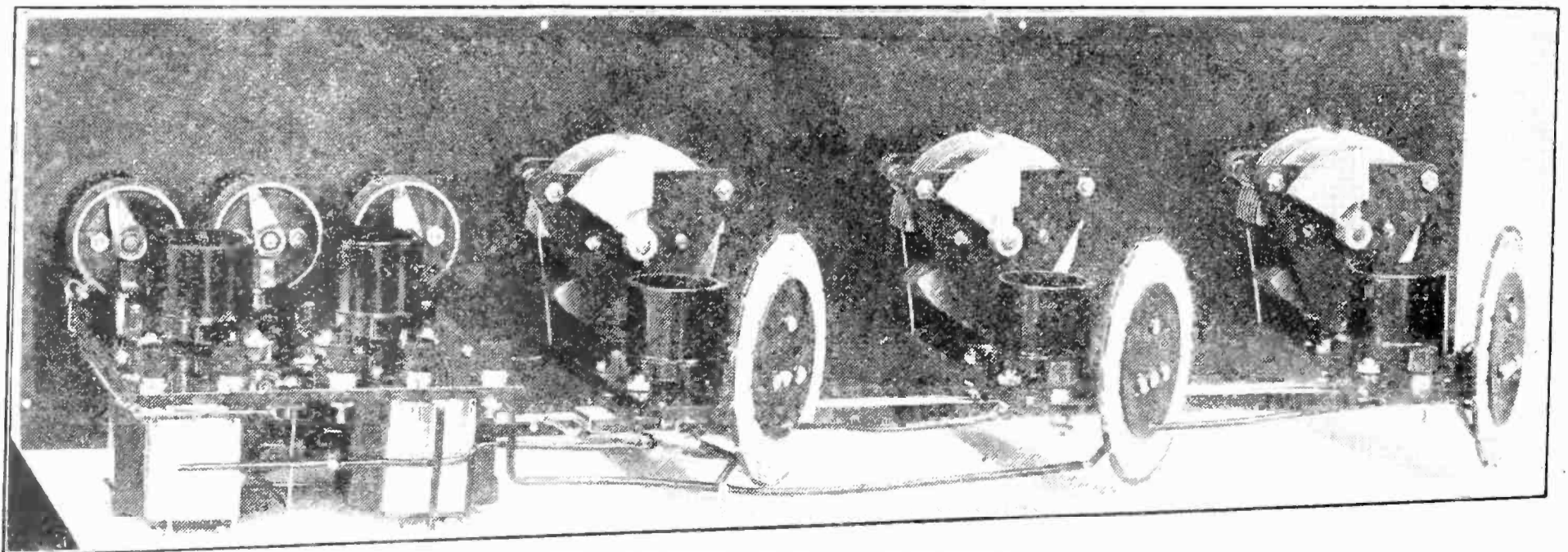

THE DERESNADYNE RECEIVER

Employing two stages of tuned radio-frequency amplification, detector, and two stages of audio-frequency amplification. Designed for broadcast reception, this receiver will give good loud speaker volume over fairly long distances. Made by Andrews Radio Company, 506 Webster Bldg., Chicago, Ill.

"THE AIR IS FULL OF THINGS YOU SHOULDN'T MISS"



Eveready "B" Battery No. 772 for detector and amplifier. Connections at 22 1/2 and 45 volts. Three Fahnestock Clips. Approximate over-all dimensions, 8 1/4 in. x 3 1/4 in. x 7 3/4 in.

Sustained power!

WHERE table or cabinet space is limited, use this new vertical 45-volt Eveready "B" Battery No. 772. It has the same long life, the same steady high power as the horizontal Eveready 45-volt "B" Battery, but because it stands upright it takes less than half the table space.

Tables and most battery cabinets have more headroom than floor space. This battery is built in recognition of that fact. It fits the Radiola Super-Heterodyne cabinet perfectly.

Many multi-tube receiving sets use a "hard" detector tube which does not require fine adjustment of "B" voltage, so the new Eveready Vertical 45-volt "B" has but three plainly marked terminals, negative, plus 22 1/2 and plus 45 volts.

Standing upright to save space, made of large, powerful cells to last longer, here is the battery you've been looking for.

Manufactured and guaranteed by
NATIONAL CARBON COMPANY, Inc.
 New York San Francisco
 Headquarters for Radio Battery Information

Canadian National Carbon Co., Limited, Toronto, Ontario
 If you have any battery problem, write G. C. Furness, Manager, Radio Division, National Carbon Co., Inc., 126 Thompson Ave., Long Island City, N. Y.



EVEREADY
Radio Batteries
-they last longer

Eveready 6-volt Storage "A" Battery

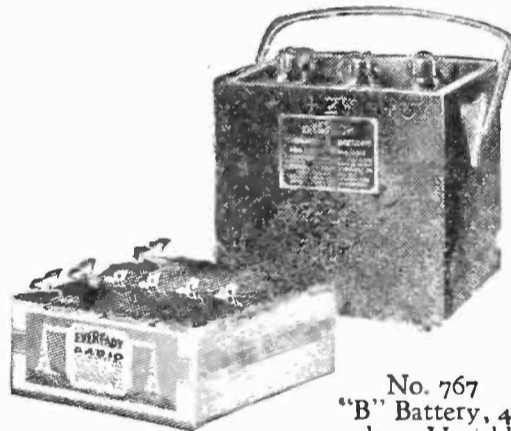

No. 767 "B" Battery, 45 volts. Variable taps. Fahnestock Clips



No. 766 Eveready "B" 22 1/2 volts. Six Fahnestock Spring Clip Connectors



No. 771 Eveready "C" Battery. Clarifies tone and prolongs "B" Battery life

No. 764 The Space Saver. Vertical 22 1/2-volt "B" Battery



No. 7111 Eveready Radio "A" Dry Cell. Specially manufactured for use with dry cell tubes

Among Our Authors

ZEH BOUCK, who is one the most active radio writers we know, turns this month from writing about broadcast apparatus to describing an excellent amateur receiver. And he is well qualified to do it, since he is at once an ardent broadcast listener and deep-dyed amateur. His amateur radio telegraph station, 2PI, is well known throughout the second radio district. Just now the active Mr. Bouck is weighing methods on how to take his vacation in Europe and get back in three weeks without resorting to an airplane.

JAMES C. YOUNG is a newspaper writer whose home is in New York City. "It was a cold, thick day when we went out to see those gently tossing ships, that were waiting for the business which came," he says. It is good to think in these humid days that it wasn't so long ago that people were wearing overcoats.

WILLIAM P. GREEN, through the associations of his daily business has been in close touch with the devious ways of some advertisers in that vast field. For the last six years, it has been his duty, as associate director of the



WILLIAM P. GREEN

Associated Advertising Clubs of the World to investigate methods and results. In this interesting and authoritative article, "The Way of the Transgressor," he discloses some of the malpractices which have had an unfortunate effect on other industries and may discredit radio if allowed to go unchecked.

J. E. ROBERTS is one of the most active and interested of the many broadcast listeners in Cleveland, Ohio. The adaptation he describes of the Roberts Knock-Out receiver came as a result of the great success he had with the first model of that receiver which he built from Mr. Walter Van B. Roberts' article in RADIO BROADCAST for April.

JACK IRWIN whose absorbing story of the unsuccessful voyage of the *America* appears in this number, was born in Australia and educated at King's School, Melbourne. His first experience with a telegraph key was on the overland circuit connecting the cable landing at Java with the northwest of Australia. He served with the Australian troops in the Boer War as signaller,

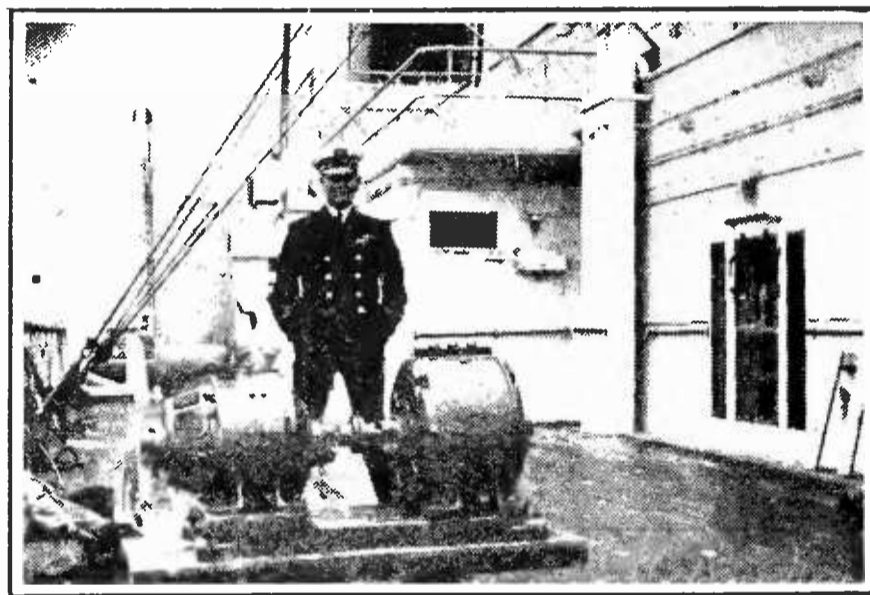

JACK IRWIN

and later came to the United States with the Commercial Cable Company. He joined the Marconi company as operator in 1906 and has been active in radio ever since. The accompanying photograph shows Mr. Irwin on the SS *Leviathan* standing behind one of the motor generator sets which he installed on that vessel. Mr. Irwin was assigned as one of the six operators on the *Leviathan* when she became the property of the Shipping Board. He is now shooting across the country as pilot of RADIO BROADCAST'S COVERED WAGON.

J. E. DREYER, JR., is an instructor in the department of electrical engineering Stevens Institute of Technology, at Hoboken, New Jersey. He has assisted Professor L. A. Hazeltine, of that same institution, in development and testing work with the neutrodyne set.